

Radio Topics

20 Cents

May
1922



Circulation of
This Issue
78,300

*Detroit Radio Station
General Electric Station
Grain Reports by Radio
Lackawanna R. R. Tests
Radio*

*and many other
interesting articles*

Simpson

LARGEST STOCK IN THE MIDDLE WEST OF QUALITY RADIO APPARATUS

C. W. TRANSFORMERS		CONDENSERS		VACUUM TUBES	
No.	Price	No.	Price	No.	Price
No. UP-1368 Radio Corp.	325 watt. \$25.00	No. UC-1819 Farodon, for receiving.	\$ 8.75	No. UV-200 Radiotron, each	\$ 5.00
No. UP-1016 Radio Corp.	750 watt. 38.50	No. UC-1831 Farodon, for transmit'g	9.00	No. UV-201 Radiotron, each	6.50
50 watt 350 volt, Acme, unmount'd.	12.00	No. UC-1631 Filter, 1/2 mid-750 V.		No. UV-202 Radiotron 5 Watt	
200 watt 550 volt, Acme, mounted	15.00	Radio Corp.	1.35	Radio Corp.	8.00
200 watt 550 volt, Acme, unmount'd.	15.00	No. UC-1632 Filter, 1 mid-750 V.		No. UV-203 Radiotron 50 Watt	
200 watt 550 volt, Acme, mounted	20.00	Radio Corp.	1.85	Radio Corp.	30.00
500 watt 1000-1500 volt, Acme unmount'd	20.00	No. UC-1634 Filter, 1/2 mid-1750 V.		No. UV-204 Radiotron 250 Watt	
500 watt 1000-1500 volt, Acme mount'd	25.00	Radio Corp.	1.50	Radio Corp.	110.00
Choke Coils		No. UC-1635 Filter, 1 mid-1750 V.		Electron Relay	5.00
No. UP-1625 Filter Reactor, Radio		Radio Corp.	2.00	APVT Amplifier	6.50
Corp. 160 M. A. Capacity	\$11.50	No. UC-1014 Plate and Grid, 3000 V.		Kenotron Rectifiers	
No. UP-1627 Filter Reactor, Radio		.002 mid., Radio Corp.	2.00	No. UV-216 20 Watt Radio Corp.	\$ 7.50
Corp. 300 M. A. Capacity	15.75	No. UC-1015 Antenna Series, 7500		No. UV-217 150 Watt Radio Corp.	26.50
No. UP-415 Plate Circuit Reactor,		V. .0003, .0004, .0005 mfd.,		Tube Sockets	
Radio Corp.	5.75	Radio Corp.	5.40	No. UR-542 Porcelain Radio Corp.	\$ 1.00
Acme Single 150 M. A. Capacity	4.00	No. UC-1803 Special-10,000 V.		No. UT-541 Porcelain Radio Corp.	2.50
Acme Single 500 M. A. Capacity	6.00	.000025 mid., Radio Corp.	5.00	No. UP-552 Bakelite Radio Corp.	1.50
Acme Double 150 M. A. Capacity	6.00	No. UC-1806 Special 6,000 V. .002		No. UT-501 Mountings Radio Corp.	4.00
Acme Double 500 M. A. Capacity	8.00	mid., Radio Corp.	7.00	No. UT-502 Mountings Radio Corp.	4.00
Modulation Transformers		No. 577 Type Dubilier mica Cond.,		No. GR-1 General Radio	1.50
No. UP-414 Microphone, Radio Corp.	\$ 7.25	Grid Cond., By Pass, Antenna		No. R-400 De Forest Inverted Type	2.75
No. A-3 Acme Semi-mounted	5.00	Series Cond., etc. 1000 Volts	2.00	No. 550 Murdock, Bakelite	1.00
Filament Heating Transformers		Filters		Ace	1.50
Thordarson, unmounted, for 250 Watt		No. 170 Tuska (special price)	\$11.20	Tone Wheels	
Tubes, 10 V. Secondary	\$ 8.00	Microphones		No. PX-1638 Rotary Grid Chopper,	
Thordarson, mounted, for 250 Watt		No. 323W Western Electric	\$ 4.00	Radio Corp.	\$ 7.25
Tubes, 10 V. Secondary	10.00	No. 260W Federal	7.00	Motor Shaft Bushings, 1/4 or 5/16 in.	.20
Thordarson, unmounted, for 450 Watt		No. M-3 Hand Type, Joy and Kelsey	6.00	Meters	
Tubes, 10 V. Secondary	12.00	Grid Leaks		No. UM-530 Antenna Ammeter, 0-2.5	
Thordarson, mounted, for 450 Watt		No. UP-1719 Transmitter 5000 Ohm		Amperes, Radio Corp.	6.00
Tubes, 10 V. Secondary	15.00	(5 Watt Tubes) Radio Corp.	1.10	No. UM-533 Antenna Ammeter, 0-5	
Acme 50 Watt, Fully Mounted	12.00	No. UP-1718 Transmitter, 5000 Ohm		Amperes, Radio Corp.	6.25
C. W. Inductances		(50 and 250 Watt Tubes) Radio		No. 74 Jewell Thermo-Couple	12.00
No. UI-1008 Osc. Trans. Radio Corp.	\$11.00	Corp.	1.65	No. 54 Jewell-D. C. Flush Type	
No. CW-100 Edgewise wound copper,		Motor Generators		0-100, 200, 300, 400, 500 Milli-	
25 turns	10.00	Robbins & Meyers 100 Watts, 500 V.		amperes	8.00
No. 181 Tuska (Special Price)	5.25	110 Volt A. C. 60 Cycle Service.	\$68.00	No. 127-A General Radio Hot Wire	
No. 182 Tuska (Special Price)	7.00	Robbins & Meyers 200 Watts, 500 V.		.05, 1, 2.5, 5 and 10 Amperes...	7.75
No. 183 Tuska (Special Price)	8.75	for 110 Volt A. C. 60 Cycle			
		Service	85.00		

Westinghouse Regenerative Receivers	
Type RC, Detector and Amplifier in	
one Cabinet	\$130.00
Type DA, Detector and Two-Step Am-	
plifier	68.00
Type RA, Tuner	68.00
Type RE, Aeriola, Jr.	25.00
Type CB, Loading Coil	5.00
Grebe Regenerative Receivers	
No. CR-3 170-600 Meters for Relay	
Work	\$65.00
No. CR-5 150-3000 Meters with Tube	
Control	80.00
No. CR-8 150-1000 Meters with Tube	
Control	80.00
No. CR-9 150-3000 with Detector and	
Two-Step	130.00
Audion Control Panels	
No. RORA Grebe, with cabinet	\$12.50
No. RORH Grebe, with tick, connec-	
tions	17.50
No. RORK Grebe, Two-step Amplifier	55.00
Transmitting Condensers (Dubilier)	
No. 12225-500 Watts 14000 V. .007	
cap.	\$30.00
No. 12226-1000 Watts 21000 V. .007	
cap.	45.00
Variable Air Condensers	
No. 3 Chelsea, .0012 mfd. Unmounted.	\$ 4.75
No. 4 Chelsea .0006 mfd. Unmounted.	4.25
No. 3660 Murdock, Panel Mounting,	
43 Plates	4.00
No. 3680 Murdock, Panel Mounting,	
23 Plates	3.25
No. 11 Plate Perfection K. D. Con-	
denser	1.25
No. 21 Plate Perfection K. D. Con-	
denser	1.60
No. 41 Plate Perfection K. D. Con-	
denser	2.25
No. CV-500 De Forest Variable Con-	
densers (Parts)	3.20
No. CV-1003 De Forest Variable Con-	
densers (Parts)	5.60
No. CV-1005 De Forest Variable Con-	
densers (Parts)	6.25
Grid Leaks	
Nos. UP-509 to UP-525 .05 to 3	
Megohm Radio Corp.	.75
Rotary Spark Gaps	
No. P-1 Benwood Sound-Proof	\$30.00

Benwood "Super" Gap	22.00
Rheostats	
No. PR-535 Filament Panel Mounting	
Radio Corp.	\$ 3.00
No. PT-537 Filament Panel Mounting	
Radio Corp.	10.00
No. PR-536 "A" Battery Potentio-	
meter Radio Corp.	2.00
No. 81 Remler 3 Ampere Capacity	1.75
No. 12474 Paragon Back Mounting	1.50
Amplifying Transformers	
No. UV-1714 Radio Frequency Amp.	
Transformer	6.25
No. UV-712 Intervalve Radio Corp.	\$ 7.00
No. A-2 Acme, Semi-mounted	5.00
No. 226-W Federal	7.00
No. AA 3 to 1 Ratio Unmounted	3.35
No. AA 3 to 1 Ratio Mounted	4.25
No. AA 10 to 1 Ratio Unmounted	3.50
Variometers and Variocouplers	
Mesco Variometers	\$ 5.00
Mesco Variocouplers	4.00
No. 500 Remler Variometers	6.00
No. 503 Remler Variocouplers	5.40
Telephones (Pair)	
No. 480 Mesco 1000 Ohms	\$ 6.50
No. 1 Type "C" Baldwin's Navy	
Standard	12.00
No. 2 Type "E" Baldwin's Super-sensi-	
tive	13.00

The following material is offered subject to prior sale only:
1 No. P-100 De Forest Control Panel, less "B" Batteries and Tube; just the thing for experimental work; reg. price \$67.50; special sale price \$25.00

Brandies' Transatlantic 2800 Ohms	12.00
Brandies' Navy Type 3200 Ohms	14.00
Brandies' Superior 2000 Ohms	8.00
No. 56 Murdock 2000 Ohms	5.00
No. 56 Murdock 3000 Ohms	6.00
Loud Speakers	
Type R-3 Radio Magnavox	45.00
Station Type Vocaloud	30.00
Laboratory Type Vocaloud	25.00

Mesco Loud Speaker (the latest Loud Speaker on the market using Type "C" Baldwin Phones)	
Victrola Attachment	15.00
Graphonola Attachment	15.00
Plugs	
No. 47-A Western Electric, Brass	\$.75
No. 12159-W Federal, Brass	2.00
No. 15 Federal	1.75
Jacks	
No. 12158-W Federal N. P. 2 Circuit	\$ 1.00
No. 12157-W Federal N. P. Closed Circuit	.85
No. 12156-W Federal N. P. Open Circuit	.70
No. 1435 Federal Filament Control	1.20
No. 1438-W Federal Filament Control	1.50
Mesco Wireless Spark Coils	
No. 459 1/4 in. Operates on 5 Dry Cells	\$ 4.50
No. 460 1/2 in. Operates on 5 Dry Cells	5.40
No. 461 3/4 in. Operates on 5 Dry Cells	7.20
"A" and "B" Batteries	
No. 760 E. R. Batts 4 1/2 V, each new style; same as 703, with flexible leads; each	.27
No. 763 Everready "B" 22 1/2 Volt	\$ 2.25
No. 766 Everready "B" 22 1/2 Volt large size	3.00
No. A-141 Red Seal Sparker "A"	2.28
6 Volt 60-80 amp. Vesta Batt, each	20.00
Battery Charging Equipment	
Rectigon Battery Charger, 2 1/2 amperes	18.00
Rectigon Battery Charger, 6 amperes	28.00
Bulbs only, 2 1/2 ampere size	4.00
Bulbs only, 6 ampere size	8.00
Antenna Wire	
No. 10177-7 Strand No. 22 Tinned Copper	Per C. Ft. 1.50
No. 10178-7 Strand No. 20 Hard Drawn Copper equivalent to No. 12	2.00
No. 14 Soft Drawn Copper (80 feet per lb.); per lb.	.40
No. 443-7 Strand No. 20 Phosphor-Bronze	2.50
(Prices for Wire in larger quantities on application)	

OUR NEW WIRELESS CATALOGUE NOW READY FOR DISTRIBUTION

MANHATTAN ELECTRICAL SUPPLY CO., Inc.

17 Park Place, New York 114 SOUTH WELLS ST., CHICAGO 604 Mission St., San Francisco
1106 Pine Street, St. Louis

Federal RADIO JACKS AND PLUGS

Are Standard Equipment in All Types of Apparatus

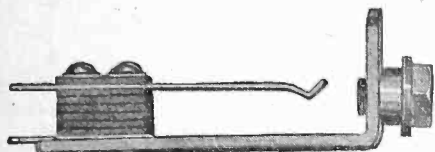

No. 1421-W—Open Circuit
Price each \$0.70

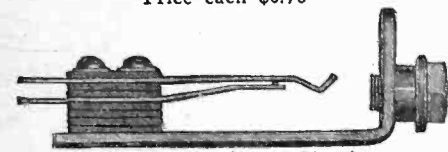

No. 1422-W—Closed Circuit
Price each \$0.85

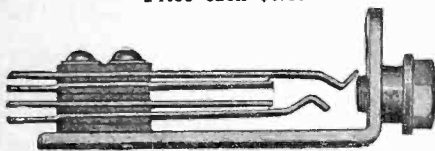

No. 1423-W—Double Circuit
Price each \$1.00

THERE ARE MANY CHEAP
IMITATIONS
ON THE MARKET BUT NONE CAN
COMPARE WITH THE GENUINE
FEDERAL

FEDERAL RADIO JACKS

The frame is of nicked brass, $\frac{1}{2}$ " wide, $\frac{3}{4}$ " high; overall length, $3\frac{1}{2}$ ", Bakelite insulation and silver plated springs with pure silver contacts are used.

Designed for use with Nos. 15 and 1428-W Plugs.

For mounting on $\frac{1}{4}$ " panel only.

FOR BEST RESULTS
DEMAND GENUINE FEDERAL



No. 1428-W
Price each \$2.00



No. 15
Price each \$1.75

FEDERAL RADIO PLUGS

No. 1428-W Plug is a two-circuit plug, very substantially made, and will stand a breakdown test of 500 volts. Rubber bushing on cord end prevents short circuiting of the telephone cord on the plug through excessive wear.

No. 15 Universal Plug is a radical departure from the ordinary telephone plug. Unlike others of similar design, spade terminals, pin connections, stranded or solid wire may be used without soldering. Consists of only five simple parts—two highly finished Bakelite moulded pieces, the plug with its connecting screws and a brass screw and collar for holding the two together. This connecting screw does not come in contact with electrical circuit in any way.

Federal Telephone and Telegraph Company

BUFFALO, N. Y.

'CHI-RAD' STORAGE 'B' BATTERY



The hit of the season—a real Storage "B" Battery with pasted plates which can be re-charged as easily as your "A" Battery. Ideal for Laboratory and Experimental use as well as all Radio Equipment employing Vacuum Tubes. Equally desirable on detecting amplifying or transmitting tubes as source of plate voltage.

PRICES

22-Volt Battery as shown, \$6.00. (Add PP on 8 lbs.) Single Cells, \$0.50. (Add PP on $\frac{1}{2}$ lb.) Wood Base, \$1.00. (Add PP on 1 lb.)

SPECIFICATIONS

Block size, $2\frac{3}{4}$ " x 9".
Tubes, 1" Diam. 5" high.
Voltage per cell, 2 volts.
Shipped dry with simple directions for setting up and charging.
Capacity 2 Amp. Hours—will operate 1 tube 1,000 hours on one charge.

REMOVAL NOTICE—Don't forget we are now located in our new Ground Floor Salesroom at 415 South Dearborn St. Come and see us soon—we will carry the most complete stock of High Grade Radio Supplies in the Middle West.

Dealers—Chi-Rad Storage Batteries will be widely imitated, but never excelled—why not sell your customers the 100 per cent, ORIGINAL Battery backed up by our guarantee? It will mean dollars in your pocket in the end. Send us your orders now!

CHICAGO RADIO APPARATUS CO., Inc.

415 South Dearborn Street

Chicago, Illinois

RADIO COURSE FREE

the minute and includes all the latest wireless developments. Mail the coupon for full particulars. L. L. Cooke, Chief Engineer.

For a limited time I will give my new Radio Course, just completed, absolutely FREE with my Course in Practical Electricity. This new course is right up to the minute and includes all the latest wireless developments. Mail the coupon for full particulars. L. L. Cooke, Chief Engineer.

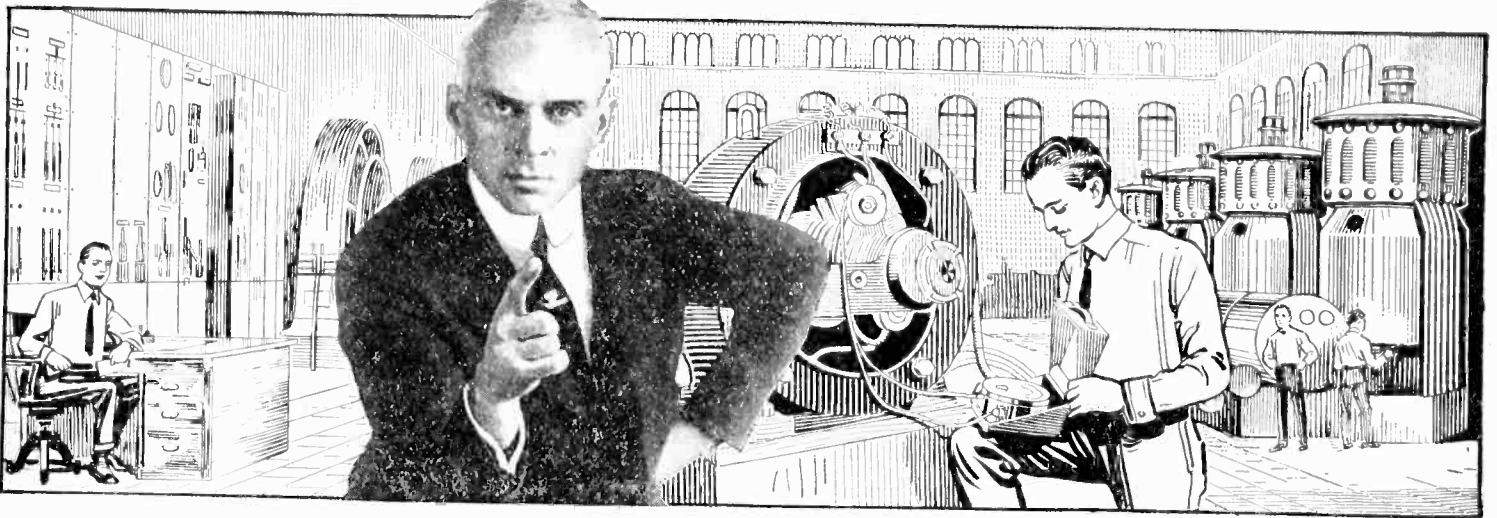

ELECTRICITY NEEDS YOU

I Will Train You at Home

Stop right here. This is YOUR opportunity! Electricity is calling you, and the Electrical Business is in for a tremendous increase. But it needs more trained men—at big pay. By my Home Study Course in Practical Electricity I can train you for these positions.

EARN \$70 TO \$200 A WEEK

You've always had a liking for Electricity and a hankering to do electrical jobs. Now is the time to develop that talent; there's big money in it. Even if you don't know anything at all about Electricity you can quickly grasp it by my up-to-date, practical method of teaching. You will find it intensely interesting and highly profitable. I've trained and started hundreds of men in the Electrical Business, men who have made big successes. YOU CAN ALSO

BE A BIG PAID ELECTRICAL EXPERT

What are you doing to prepare yourself for a real success? At the rate you are going where will you be in ten years from now? Have you the specialized training that will put you on the road to success? Have you ambition enough to prepare for success, and get it?

You have the ambition and I will give you the training, so get busy. I am offering you success and all that goes with it. Will you take it? I'll make you an ELECTRICAL EXPERT. I will train you as you should be trained. I will give you the benefit of my advice and 20 years of engineering experience and help you in every way to the biggest possible success.

CHIEF ENGINEER COOKE
Chicago Engineering Works
Dept. 1375, 2150 Lawrence Ave.
CHICAGO, ILL.

Dear Sir: You may send me entirely free and fully prepaid, a copy of your book, "How to Become an Electrical Expert," and particulars about your Home Study Course in Electricity and the Free Radio Course.

Name

Address

City..... State.....

Valuable Book Free

My book, "How to Become an Electrical Expert," has started many a man on the way to fortune. I will send a copy, free and prepaid, to every person answering this advertisement.

Act Now!

Good intentions never get you anywhere. It is action, alone, that counts. NOW IS THE TIME TO ACT.

L. L. COOKE, Chief Engineer
CHICAGO ENGINEERING WORKS
2150 LAWRENCE AVENUE
Dept. 1375, Chicago, U. S. A.

FREE!

Big Electrical Outfit

A fine outfit of Electrical Tools, Instruments, Materials, etc., absolutely FREE to every student. I will also send you FREE and fully prepaid—Proof Lessons to show you how easily you can learn Electricity and enter this splendid profession by my new, revised and original system of Training by Mail.

I Guarantee You Satisfaction

So sure am I that you can learn electricity—so sure am I after studying with me, you, too, can get in the "big money" class in electrical work, that I will guarantee under Bond to return every single penny paid me in tuition if, when you have finished my Course, you are not satisfied it was the best investment you ever made.

Earn Money While Learning

I give you something you can use now. Early in my Home Study Course I show you how to begin making money in Electricity, and help you get started. No need to wait until the whole course is completed. Hundreds of students have made several times the cost of their course in spare time work while learning.

RADIO TOPICS

Vol. II

MAY, 1922

No. 4

The Detroit News Radio Broadcasting Station

By EDWARD J. BECK

IN Fort Pierce, Fla., 1,300 miles from Detroit, young people dance to music played in the radio room of the Detroit News.

In Calais, nestling in a faraway corner of the State of Maine and 1,000 miles from Detroit by air line, the harmonic splendors of symphonies rendered by the Detroit Symphony Orchestra are eagerly awaited.

Eureka, S. D., sends word that it

enjoyed the remarks of Babe Ruth as they were hurled immeasurably swifter than the Bambino's fastest hit, through the night air to that remote point.

Radio enthusiasts in cold Alaska and tropical Honduras have written messages of gratitude to the Detroit News for its enterprise in bringing Broadway hits and the renditions of leading virtuosos to them.

The Detroit News was the first newspaper in the United States—and and so far as known in the world—to install a radio broadcasting station as part of its regular equipment. The News still retains its position of supremacy among newspapers having radio departments, for efficiency of equipment, elaborateness of programs and amounts expended for radio.

The first transmitting set of the De-

troit News was installed August 20, 1920. On August 31 the News announced to the public that from that day on programs would be broadcast daily. Every week-day since that time, without interruption, news bulletins, music and, with the growth of the department, a wider variety of features have been transmitted.

The original apparatus consisted of a De Forest Type OT-10 transmitter having a theoretical range of 100 miles. Many changes and replacements were made in this equipment from time to time so that by December, 1921, the concerts of the Detroit News were being received at points as remote as Atlanta, Ga., and Belleville, Ill. A 200-meter wave-length was used. In 1920 there were only about 300 receiving sets in the hundred-mile circle about Detroit. Now there are probably as many of these sets in that city as pianos or electric washing machines. Due to the publicity of the Detroit News and its splendid programs, the city has literally gone "radio crazy." Clothing stores, candy stores and even former popcorn booths are offering radio supplies and parts for sale at the present time.

The present transmitting set, installed in January, 1922, is the Western Electric Type 1A. It was espe-



The Radiophone Broadcastinging Station, WWJ, owned and operated by the Detroit News, is probably the most efficient and well liked station in the Middle West.

cially designed for the requirements of the Detroit News. It has a 2,000-volt generator and 500-watt output. The wave-length used is 360.

A four-wire aerial 330 feet long extends from the News building to the Fort Shelby Hotel. It is 130 feet high. Ordinarily only 220 feet of the aerial is used. The generator is not run at full capacity, 1,600 volts only being used.

The present Detroit News radio staff consists of eight persons. Of this number three handle the technical end and the remainder manage the programs and do editorial work in connection with the department. A volume of correspondence amounting to 400 letters daily is handled.

The first concert of the world-famous Detroit Symphony Orchestra was broadcast on February 10, 1922. Since that time two or three concerts by this organization have been sent out weekly by the News in addition to its regular program. The symphony concerts usually come at 3:30 Sunday afternoon and Thursday and Friday nights.

Theatrical headliners and leading concert attractions began to constitute the bulk of the program in December, 1921. Radio was even at this recent time largely unknown to the public-at-large. The people of the stage exhibited many of the naive reactions of ordinary folk when they made their radio debut at the News auditorium. Favorites who felt perfectly at ease on the stage or in the spotlight were overawed by the ominous looking little receiver that carried their numbers to thousands of homes and showed symptoms of "radio fright." The new device was as much a mystery and source of wonder to them as to any other uninitiated visitor.

Frank Tinney, the comedian, was so mystified that he actually wondered if he was not being hoaxed. Only when he heard music relayed back by telephone from Windsor, Ontario, situated across the river from Detroit, could he be completely convinced that

a trick was not being played on him.

The News in reporting one of the early concerts at which professional talent was used spoke of the difficulty experienced by actors in presenting their number without applause to spur them on. Said the News: "The receiver is not a very appreciative instrument, at least in appearance. One can't tell from the looks of the telephone whether his number is liked or not.

response from the audience to keep it progressing."

The daily schedule of the Detroit News Radio Broadcasting Station, WWJ, is:

11:30-11:55—Phonograph music, 360 meters.

3:30—Market and weather reports, 485 meters.

7:00-8:15—Entertainment and concert, 360 meters.*



Station WWJ has been highly commended for its very interesting programs. The orchestra shown here is playing in its new sound-proof radio auditorium built at an expense of \$75,000.

"This was quite baffling to Ernie Ball, the famous composer. He sang one or two of his most popular numbers, heard no applause and finally looked at the telephone in a manner that registered blind rage. And then he stuck out his tongue at the instrument, which seemed to relieve his feelings a lot, for he swung immediately to another selection.

"In the case of Frank Tinney, that celebrity had to be assured again and again that he was not being spoofed. The thing seemed so uncanny to him. And he missed the applause because the nature of his act required some

Sunday, 3:30—Detroit Symphony Orchestra, 360 meters.

Thursday, 8:20-9:45—Detroit Symphony Orchestra, 360 meters.

Friday, 8:20-9:45—Detroit Symphony Orchestra, 360 meters.

The evening program ordinarily includes from six to twelve distinct features. An effort is made to provide such a wide variety of numbers that all tastes may be satisfied. A ten-minute address by a prominent man is usually featured. Each program has both vocal and instrumental music, popular and classical music, and a variety of instruments.

As to the Future Possibilities of Radio

What will the radiophone do in the life of the nation? Listen to Dr. Alfred N. Goldsmith, director of the research department of the Radio Corporation of America:

"Radio broadcasting will provide the school, the theater, the lecture platform of the future. A man will be able to have in his own home the latest play, the opera, the lecture—or a political debate. He will not be required to accept one of these alternatives at any given time, but will be able to choose any of them, since they will be sent out concurrently on different wave lengths.

"The result on the political life of the country will be incalculable. The nation will be integrated to a degree never conceived of, and the resulting effect on our life and institutions is equally inconceivable.

Radio will not replace either the wire telephone or the wire telegraph. It has a field of its own. It has the future which Moise held in his hands with his first crude model of the telegraph and the future which Alexander

Graham Bell dreamed of when he perfected the telephone.

Major General Squier, chief signal



Dr. Steinmetz, the world's most renowned electrical engineer, is an ardent radio fan. He is shown here in the studio of the General Electric's Station, WGY.

officer of the United States army, is reported to have perfected a method for getting radio musical programs from ordinary electric light wires. According to Professor Michael J. Pupin of the department of electro-mechanics at Columbia University, the discovery of General Squier will be practicable only in communities where the electric wiring is strung on overhead poles, but in cities where the wires are carried in conduits the "wired wireless" will not work. Reports of General Squier's invention state that no antenna was used, but that the plug of the wireless receiver was inserted in an ordinary lamp socket, while the transmitter was attached at a distance to the lighting wires. The messages and music were clearly heard. According to Professor Pupin it is impossible for high frequency currents employed in wireless to travel through underground cables, but amateurs who live in suburbs where lighting wires are exposed may plug in and use the lighting wires for communication.

The New Radio Broadcasting Station WGY

A RADIO broadcasting station, more powerful than any now sending out programs, has been installed by the General Electric Company at its plant in Schenectady, N. Y.

From the roof of a five-story factory building, two towers 183 feet high and spaced 350 feet apart, support an antenna at such height as to give the wireless waves unobstructed freedom to travel equally well at a speed of 186,000 feet per second in all directions.

This station has not been regularly operated nor has advance announcement been made of the impromptu or test programs sent out, which would cause amateurs to be listening, yet, letters have been received from such distant points as Cedar Rapids, Iowa, Minneapolis, and Santa Clara, Cuba, the latter place 1,450 miles distant, announcing that the programs have been heard. These reports come from operators who, in an evening's experimenting with their receiving sets, have accidentally come upon the waves from Schenectady and are no indication of the distance this station may be heard.

Broadcasting stations with but a fraction of the power of the G-E station, have been heard at distances of 2,000 miles or more under favorable atmospheric conditions.

The General Electric station has been licensed to operate on a 360-meter wave length under the call letters of W. G. Y. It is equipped with the most modern of radio apparatus, including the multiple-tuned antenna which, because of its many advantages, has been installed in Radio Central, the world's most powerful commercial station, at Rocky

Point, L. I., and other trans-oceanic stations of the Radio Corporation of America.

A three-room studio, where the programs are produced, is located in a company office building, 3,000 feet from the transmitting station. One room is used as a reception room for the artists, where they may sit and chat until their time on the program arrives without danger of interfering with what is going on in the studio. The second room is the studio, where a concert grand piano, victrola, an organ and other equipment for the artists are to be found. Here a number of portable microphones, which are commonly known as pick-up devices, can be shifted about to locations best suited for the reception of announcements, musical numbers or whatever may be sent out. In the room on the opposite side of the studio is apparatus for amplifying the sound waves before they are transmitted by wire to the broadcasting station.

A switchboard in the studio, which lights a red light when the station is in operation, thus warning persons in the room that whatever they might say will be sent out to thousands of cars of an invisible audience, is within reach of the studio director at all times. Not until he throws a switch can anything reach the antenna. A

Continued on page 31)



The answers to about 80% of the questions generally asked will be found here.

The Radiophone Broadcasting*

By EDWARD M. SARGENT
General Manager Western Radio Electric Co.

FIFTEEN years ago radio was known only to a few who followed the sea as a profession or to those who were ship owners. It was to them a means, possible if not practical, of saving a vessel in distress. To the every-day American it was a thing of mystery—a thing of which he had read many wonders, which seemed to work contrary to all the laws to which he was accustomed. How could several stations talk at once and still not interfere, one with the other? How could a station know that its message was being received? How could it call another? How could so many receive the same message and still not interfere? When the wind was blowing or when it rained, could they still communicate?

Today radio is entering every home, riding on the crest of a wave of popularity that is growing rapidly. It is still mysterious, but since the advent of the radio telephone it has become practical and is now a fascinating source of entertainment and instruction to which every one has access. No knowledge of the wireless code is necessary. A simple adjustment of a few knobs is all that is required to bring in radio music, the latest news, stock reports, baseball scores, talks by lecturers of national reputation and countless other features which are putting the radio telephone in the corner hitherto occupied only by the phonograph in the home.

With this wave of popularity has come a demand from everywhere to know about it, how it works, who can use it, what it will cost and what results can be expected.

Radio phone broadcasting was started in a small way about a year before the outbreak of the World War. During the winter of 1916 the De Forest Company of New York sent out phonograph music by radio two or three nights a week from a station erected at their factory. Their listeners consisted mainly of amateurs and experimenters in and around New York City. The receiving sets then were not highly developed for this kind of work, and before any general interest was aroused war was declared and the station shut down.

During the war a great deal of experimental work was done on the radio telephone in the army and navy, and it was developed to a point where it could be relied upon for communication over moderate distances. In 1920 Western Radio Electric Company opened a broadcasting station in Los Angeles. This was the pioneer station in the radio broadcasting field in Southern California, and succeeded in covering a range of 30 miles.

This station was erected primarily as an experimental one. It was not long before the concerts were being

received nightly in thousands of homes within a radius of 200 or 300 miles of Los Angeles. As the number of broadcasting stations increased it was possible for the owner of a receiving set to turn it on and hear all of the latest phonograph records the day they were put on sale. Connections were made with local newspapers and the farmer could turn on his radio receiver and hear the latest crop and dairy prices, the weather forecast and other news of interest to him. If a storm or cold spell were coming, he was now forewarned in time to take measures to save his crop. He could also know the latest news, the ball scores, the reports from the armament conference at Washington, the vote on the agricultural bill in Congress, almost as soon as the newspapers were off the press. For the others, there were the stock reports, financial quotations and other news of interest to every one.

Radio broadcasting has attracted such widespread popular interest that it now bids fair to supplement the phonograph and to become "the recreation of America" in every home. Almost overnight radio has been transformed from a mystifying experiment of science to a thing of practical value to every one. In addition to the radio concerts and news, there is the fascination of being able to sit in one's home and by merely adjusting a few knobs, to listen at will to radio telegraph stations in far away Japan communicating in an unknown code, to hear the trans-Atlantic stations exchanging messages and latest news, to re-tune and set one's watch from time signals, correct to a fraction of a second, sent out from Honolulu, or Manila, or Eiffel Tower, Paris.

Radio receiving sets, like automobiles, come in many different types. Each type is adapted to a particular need. First, there is the small crystal receiver, so called because it makes use of a crystal to detect the signals. This set requires no battery to run it, and consequently can be made up very cheaply. A good crystal receiver can be obtained at a complete cost varying between \$15 and \$30.

The crystal receiver is rather limited in the work it can do. It is suitable for the beginner in radio, who does not want to invest a large amount of money right away, but yet wants to keep abreast of the times and not miss the entertainment which is daily going on around him. It will not operate a loud speaking horn, as there is no battery to supply the power. It will not receive from great distances, but will give good signals in a pair of head telephones at a distance of 10 or 20 miles from a transmitting station. Distances of several hundred miles have frequently been covered with a crystal receiver, but these performances are generally regarded as excep-

tional, and a crystal set is rarely recommended for more than 20 miles.

The next best type of set is the one which uses a vacuum tube detector, the most sensitive type of detector known. Because a storage battery and a high voltage dry battery are needed for its operation, as well as two extra controlling devices, the price of the vacuum tube receiving sets is materially higher than that of the crystal sets, varying between \$50 for the cheapest to \$125 for the best of this type. These sets will give good signals in a pair of head receivers at a distance of from 20 to 200 miles from the transmitting station, and will operate a loud speaking horn when reception is over a short distance, about five miles. They have an advantage in that they constitute a permanent investment to which an amplifier can later be added to make a more powerful receiver. The amplifier cannot successfully be added to the crystal receiver, and if an amplifier set is later desired, the only part of the crystal receiver that can be used, as a rule, is the head telephone receivers.

Amplifiers are added to vacuum tube detector sets for two purposes—to increase the distance over which they can receive and to increase the strength of the signals that are already being received. The most usual combination is the detector and two-step amplifier, although at times three and four steps are added. A detector and two-step amplifier set will operate a loud speaking horn and reproduce music sent out by a transmitting set 200 miles away and will operate a pair of head receivers for radio telephone reception over distances of 500 miles and more. These sets, complete with head telephones, cost from \$150 to \$200, and with the loud speaking horn from \$180 to \$250.

No complicated overhead wires are needed to receive radio signals. The most practical receiving "antenna" is a single No. 14 or No. 12 copper wire, 50 or 75 feet to 400 feet long. The height is unimportant as long as the wire is about as high as surrounding objects. It is usually attached to the roof at one end and the other end suspended from a point as far away as convenient. No high poles are necessary. It is, however, an advantage to have the wire long, and the longer it is the better signals will be received, so long as its length does not exceed about 400 feet. No government restrictions whatsoever are placed upon radio receiving sets and no license is required to operate them.

We are frequently asked what assurance there is that music and news will continue to be sent out by radio, and that no charge will be made for it. The best assurance of this is the fact that efforts are constantly being made to improve the class of entertainment sent out, that the whole country has taken hold of the idea in such a way that it would now be im-

*From a copyrighted complimentary booklet issued by the Western Radio Electric Co., Los Angeles, Calif.

possible to go back, and that it is to the interest of every radio manufacturer and retailer to furnish as high a grade of entertainment as possible. From the very nature of radio it would be impossible to charge for this, even if it were desired to do so. The broadcasting will continue to be more varied, more instructive and more interesting. It is not a rash prediction to say that when our next President is inaugurated he will probably speak by radio and his inaugural address will be heard by the people of the whole country—in their homes.

How Radio Works

In response to numerous questions as to "how the radio works" and also to answer the questions in the first paragraph, the following explanation has been written. Although couched in simple terms, no statement has been made which is not technically correct.

When a rock is thrown into a pool of water waves are created which travel outward in all directions, the waves taking the form of ever-expanded circles and growing weaker the farther away they get from the source. The rock might be compared to a radio sending station; an object in the path of the oncoming wave—a radio receiving station. This is, however, a very elementary comparison.

Wave Length

Sometimes when a piano or violin string is struck a picture wire in the room will be found to vibrate and to send out the same note as the string. Other notes will not affect it, but one certain note will make it ring as if it had been struck itself.

The explanation is a simple problem in physics. When the violin string was struck it sent out sound waves in all directions, waves which were vibrations of the air. If the note was high there was a large number of vibrations per second, possibly 800; if it was a low note, possibly 200. It is known that sound travels through air at a rate of about 1,200 feet per second. Each vibration of the string creates a wave. If there were 800 vibrations per second, 800 waves would be created each second, and at the instant that the 800th wave was being generated the first would be 1,200 feet away. There would then be 800 waves evenly distributed along a line 1,200 feet long, or the distance between any two wave crests would be $1\frac{1}{2}$ feet. This distance is known as the wave length. It can be readily seen that the higher the frequency of vibration of the string, the shorter will be the distance between each crest, or the shorter the wave length.

Suppose a weight is hung on the bottom of the picture. It would then be found that a different note from the violin would be required to affect the picture string to a different "wave length," and although a number of different wave lengths are being sent out by the violin, the "transmitting station," only one affects the "receiving set." Thus there has been developed a system, operated by sound waves, in which communication can be carried on, and in which the receiving station can choose at will the

transmitter it wishes to receive. This system, though impractical, shows very clearly the principles on which wireless, or radio, works.

There is one important difference between sound waves and wireless waves. Sound waves are motions of the air, created by vibration of different objects. Wireless waves are vibrations of the "ether"—a medium which fills all space—and are created by the vibration of electric currents. Sound waves affect the ear, because the air waves make the sensitive ear drum vibrate. Sound waves can thus be heard. Wireless waves are not vibrations of the air, and therefore not even the waves from the wireless telephone can directly affect the ear. Some device must be used to change the electrical vibrations into sound. The most common instruments for this purpose are the telephone receiver and the loud speaking horn.

Wireless waves travel much faster than sound waves, having the same velocity as waves of light, 300,000,000 meters (186,000 miles) per second. This is fast enough to take them around the earth seven and a half times in a second. Owing to this great velocity, the length of wireless waves is much greater than that of sound waves, even though the frequencies used are also higher.

In the case of the picture string, the "tuning" was done by changing the tension on the string. It can also be done by changing the length of the string. In radio, the "tuning," which means varying the frequency or the wave length received, is accomplished by changing the coils or the condensers in the circuit. Changing these varies the "electrical length" of the circuit.

Every radio receiving set, except the most elementary, must include some method of tuning. This is particularly important in a radio telephone receiving set, as in this case all outside interference must be eliminated.

The Detector

Air waves of certain frequencies affect the ear and produce what we know as sound. Low frequency produces low notes, high frequency high notes. The ear can "hear" any frequency between about 20 vibrations per second and 15,000 per second. Twenty per second is a very low growl; 15,000 per second is a "squeak." As the frequencies used in radio are from 20,000 upward, it would be impossible to hear them if they were changed directly into sound waves. Some device must be put into the receiving set which will change the frequency of the radio current to one which is within the range of the ear. The device used to do this is known as the "detector."

The Amplifier

After the received current has passed through the detector, it has the right characteristics to operate the head telephone receivers and produce sound. How loud the sound is depends upon how much current is passing through the detector, and this in turn depends on the distance that the receiving station is from the trans-

mitter. If this distance is very great the sound produced will be weak and some arrangement will have to be used to increase the current without changing its characteristics. The same problem is encountered in long telegraph lines, and there it was solved by the use of the relay. The relay is an instrument somewhat similar in appearance to the familiar telegraph sounder or "ticker," and is operated by the weak line current. Every time it "ticks," the relay automatically throws additional battery onto the line at the point where it is installed, and thus greatly increases or "amplifies" the line current.

In radio a relay is also used for weak signals. The radio relay is called an "amplifier," and while it does the same work as the telegraph relay, it is thousands of times more sensitive. If the radio signals are very weak, or if a greater amount of power is desired from them, two, three or four relays may be used successively to increase the power. A single "relay" is called a "one step amplifier," two relays working in succession a "two step amplifier," etc.

Different classes of radio stations are assigned different wave lengths, viz., music broadcasting stations are assigned a wave length of 360 meters, ships are assigned 600 meters; time signals are sent usually on 2,000 meters; trans-Atlantic and trans-Pacific stations use long wave lengths, 10,000 and 15,000 meters.

Every transmitting station, when it is licensed, is assigned a set of call letters by its government. For example, the letters KOG are assigned to the broadcasting station of the Western Radio Electric Company. Assignment of call letters is done under international agreement and a record kept of all licensed stations. This record is a book, somewhat like a telephone directory, called a "Radio Call Book." When a station "signs" its call letters, as it is required to do each time it transmits, the location of the station can be found by looking in this call book. If one station desires to send to another, it looks up that station's call letters, calls them several times, signs its own letters and then "listens in" for the answer.

Although several stations are assigned to the same wave length, there is not the interference resulting that might be expected. In the first place, there are certain limits beyond which it is not expected that communication will be necessary. The near-by stations are the ones from which reception is usually necessary or desirable. These naturally are louder than the distant ones and hence no interference results from the distant transmitter. Again, it is almost impossible, particularly with radio phones, to tune any two transmitters to exactly the same wave length, and the characteristics of radio phones are such that the receiver must be very carefully adjusted to pick them up. Any variation in wave length would necessitate a new adjustment, so that interference is not commonly experienced. Interference among local stations is eliminated by prearranged schedules.

Radio Receptor Combined with Phonograph

THE general trend of purchasers of radio apparatus in the past few months has been toward a simply operated, self-contained instrument, especially one that might proudly grace the home or club.

And now comes the console type of cabinet, containing on one side the radio receiving apparatus, and on the other a standard phonograph. These cabinets are also being manufactured in the upright style and the popular consoles can be secured with either mahogany, walnut or oak finishings.

They are constructed to hold any of the standard receiving sets on the market today, the A and B batteries, and are so arranged that the same amplifying tone-chamber is used for both the radio and phonograph, the change of which from one to the other

ments are adjusted to the station being received. The antenna and ground connections are brought in from the rear, out of sight. Once the instruments have been tuned to the wave of the station desired the only operation to be made by the owner is to touch a switch which will turn on the current through the detector and amplifying tubes.

This style of instrument is bound to become more and more popular because of its many advantages over the fashion of having instruments spread over an entire table. Of course, there are naturally many people who prefer to experiment with a radio set, but for the many who want an instrument for the same reason they want a phonograph, to be amused and to enjoy the splendid programs being rendered

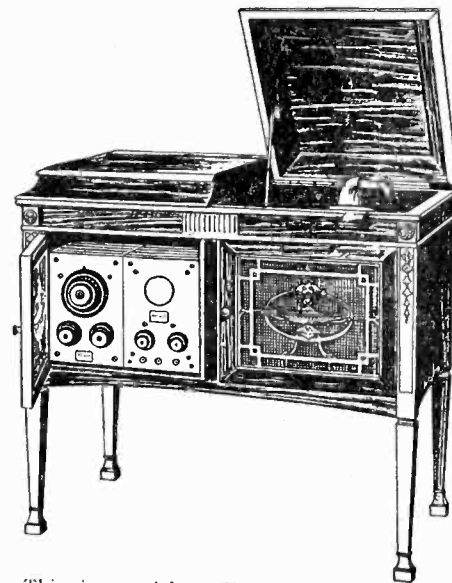

This is an Adam Period Console type of cabinet which has been equipped with a standard receiving set. The same amplifying tone chamber is used for both the radio and for the phonograph.

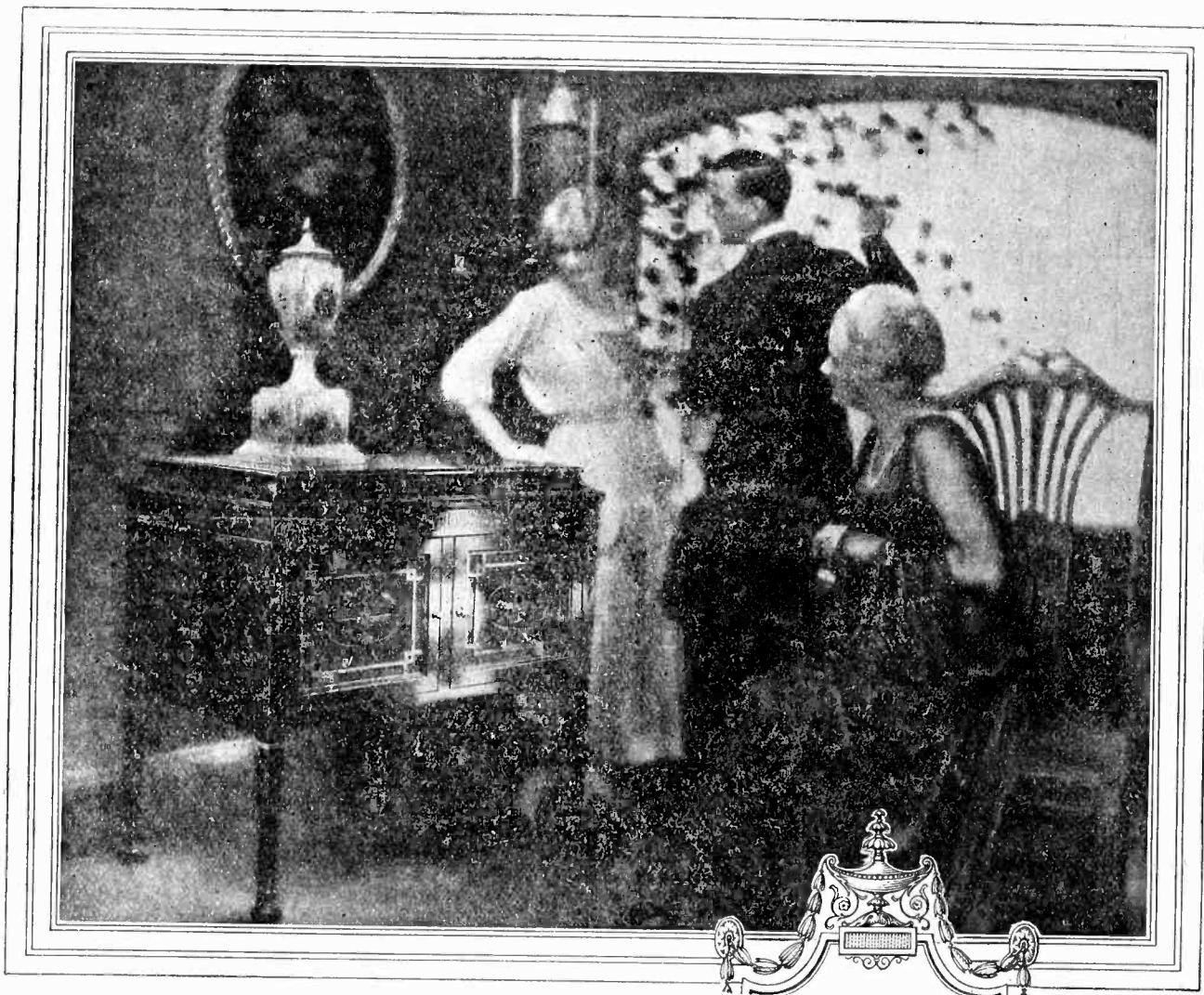

A typical illustration is here given of a console cabinet in which has been installed a radio receiving set and in the right half is a standard phonograph. Such a layout is complete and self-contained, lending beauty to the home. The time is probably not far off when the average phonograph dealer will be handling instruments of this type at a reasonable price.

requires but a very few seconds, and the cabinets in general furnish good protection to the radio instruments as well as providing a proper setting for them in the home.

In the console type there are two hinged doors made of scroll work and screening, which may be kept in a closed position once the radio instru-

by the increasing number of radio telephone broadcasting stations, it is just the thing.

Dealers will find ready sales because it is what the average lay person wants and by equipping such artistic appearing cabinets with good operating, reasonably priced radio instruments, the result is a high grade, com-

plete and self-contained affair which may be sold at a low figure. At the present time there is no difficulty in selling most anything that will detect radio signals but in a very short while the designing and merchandising of radio receiving sets will become a close parallel to that of the phonograph.

Radio Service Available to the Amateur

Radiophone Signals

IT is now possible in many sections of the United States, by means of suitable receiving apparatus which the layman can learn to operate, and which may be easily installed in any private home or office, to pick up valuable and interesting information and music broadcasted on regular schedules by a number of radio telephone transmitting stations. By the addition of suitable amplifiers and loud speaking horns, now on the market, the speech or music received may be reproduced with any intensity desired, and thus be made available to large gatherings of people without the necessity of separate head receivers for each listener.

The value of the radiophone broadcasting service is being increased by the construction of additional transmitting stations in various sections not now reached with regularity. The services of existing stations are being extended; several stations are already sending out regularly such items as weather forecasts, market and crop reports, stock market reports, special news items, time signals, church services, speeches, lectures and music of all kinds. The public is rapidly awakening to the great possibilities of the wireless telephone as a broadcasting agency, and is being educated to the relative simplicity of installing and operating suitable receiving apparatus. It appears to be only a matter of a few years before radio receiving sets will be in universal use, and all progressive farmers, bankers, newspaper offices, telephone companies, schools, county agents, and many municipal and state departments will operate their own receiving stations, to receive much valuable information by radiophone. Already a great many homes are installing receivers for the information and entertainment they afford. In Wisconsin and the adjacent states, installations costing from \$100 to \$200 can ordinarily be depended upon at night to receive the radio telephone communications and entertainments sent out by several stations within a thousand-mile radius. Unfortunately, atmospheric disturbances and other difficulties at times interfere with the reception of distant stations.

Radio Telegraph Signals

Of general interest are the accurate time signals sent out twice daily by the high powered station at Washington, D. C. (Arlington), as well as by the station at Great Lakes, Ill., and by other naval stations. For those able to read them, the messages in the continental telegraph code will always retain their fascination. Press news, weather and market reports, commercial ship and shore traffic, and various amateur messages are some of the telegraphic signals which may be overheard anywhere. While most telegraphic messages are sent at a moderately fast rate of speed and are not intelligible to the novice, certain

In response to a great number of inquiries and requests for information on elementary radio matters, this article has been prepared with the hope that it will prove useful and interesting, and that it will answer the many questions which arise in the mind of the layman or the radio amateur who has not kept up with the rapid development of the radiophone in recent years.

signals are sent more slowly and thus afford good practice to the beginner.

With equipment especially designed for the reception of long-wave signals, telegraphic signals from several European as well as Pacific stations are quite commonly overheard almost anywhere in the United States. With the exception of a few high-priced sets, the tuning coil for long waves will not also efficiently receive the ordinary short-wave radiophone signals.

RADIO BROADCASTING BY THE UNIVERSITY OF WISCONSIN

The University of Wisconsin, through its Department of Physics radio station, has taken the lead among similar institutions throughout the country in making the radiophone a practical asset to the community at large. The regular daily broadcasting of the weather forecast, by radio telegraph, was commenced in 1916. On January 1, 1921, regular daily radiophone service was added, and from the first proved successful. During the first half of the year the weather forecasts for Wisconsin supplied by the local station of the U. S. Weather Bureau were broadcasted. This means of distribution proved so practical that since September 19, 1921, in co-operation with the Wisconsin Department of Markets and the U. S. Bureau of Markets and Crop Estimates, a daily market report has been sent out. This report now covers the latest prices at the leading markets for potatoes, hogs, cattle, sheep, eggs, butter, cheese, poultry and hay.

For the sake of clearness, and to reduce the time required, a special abbreviated code has been adopted for these reports, and is employed both in the telegraphic and in the voice transmission. A supply of copy blanks, containing the code used and other information, is furnished free to all receiving stations, upon application to the Wisconsin Department of Markets, State Capitol, Madison, Wis. There are at the present time (February, 1922) between 250 and 300 receiving stations in Wisconsin and adjacent states which receive this information daily. Most of these receiving stations post the reports in conspicuous places for the information of the public; many of the receiving operators have made arrangements to furnish all or a portion of the information received daily to their newspapers, banks, county agents, farmers and other people especially interested. Several rural telephone companies are receiving the reports by radio daily, and then distribute them over the telephone to all subscribers who are interested in this service.

Since the range of the radio tele-

graph transmitter at the university station still exceeds somewhat that of the radiophone, all "broadcasts" are sent out by both radio telegraph and radio telephone. The radio telegraphic service is also appreciated by those desirous of learning the code. Three different speeds of transmission are employed, namely, a moderate rate for the market report, a moderately fast speed for the weather forecast, and finally a repetition of the weather forecast at slow speed. Beginners are thus enabled to get daily practice at a convenient speed until they are able to keep up with ordinary telegraphic traffic.

A daily time signal, sent at 1 p. m., has been included in the University Station's broadcast. A weekly radiophone concert is sent out; through the courtesy of Hook Brothers' Piano Co., local Edison distributors, the University is enabled to play a selection of the latest and best Edison phonograph records. In addition, special concerts given at the University Armory, from time to time, by famous artists, are sent out whenever arrangements therefor can be made. Every Saturday the market broadcast is followed by a short program, consisting of a musical selection and a brief, semi-technical talk on some phase of radio.

It is planned to extend further the scope of these radiophone "broadcasts" to include lectures, political speeches and several phases of University Extension work.

At night time, especially during the winter months, the range of radio signals is often considerably greater than during the day. Thus it has been possible, with the present installation, to transmit voice and music over a thousand miles in all directions, and it is confidently expected, as soon as certain improvements have been made, that under favorable conditions the radiophone signals from Madison will reach the Pacific coast. Under normal daylight conditions, however, the dependable range is about 200 miles, although several especially favorably located receiving stations have reported considerable greater daylight distances. The large ore deposits in the northern part of the state appear to have a detrimental effect upon the signals and make their reception at the present time in that part of the state uncertain. In order to overcome this handicap, and to insure dependable transmission to all parts of Wisconsin during all seasons, a radiophone transmitter of considerable greater power is highly desirable, and will eventually be installed when the necessary funds are available.

A complete broadcasting schedule of the University Station is contained in the supplement to this circular.

FACTORS INFLUENCING RADIO-RECEPTION

Methods of Signaling

There are several methods of radio signaling in use at the present time:

Damped wave telegraphy (spark), radio telephony (phone), modulated or interrupted continuous wave telegraphy (MCW or ICW), and continuous wave telegraphy (CW). All but the last one of these methods may be received with any kind of a crystal or vacuum tube detector. The reception of continuous wave telegraph signals, however, is accomplished with an oscillating vacuum tube circuit, and is generally not practicable with a crystal detector.

Wave Length

The electrical frequency of oscillation producing the radio waves is generally defined in terms of wave length, i. e., the calculated length in space of each wave, expressed in meters. Wave length thus indicates electrical quality only, and in itself is no measure of the distance to which a signal can carry. It so happens, however, that very powerful transmitters are best adapted to operate on long wave lengths, while lower powered stations can employ the shorter wave lengths more efficiently. Thus, for trans-Atlantic and long distance communications by high-powered stations waves from 5,000 to 25,000 meters are generally used. Large spark stations with ranges up to 1,000 miles or more generally employ wave lengths from 1,500 to 3,000 meters. Commercial ship and shore traffic is assigned the fixed wave length of 600 meters. A wave length of 485 meters is reserved for weather and market reports by nongovernmental stations, and all radio concerts are assigned the wave length of 360 meters. General amateur stations are restricted to 200 meters or less. For special amateur traffic, and for work between experimental or technical training stations, other waves above 200, but below 600 meters, are granted by the government. It is seen that most of the signals of general interest are sent out on wave lengths below 600 meters, and can, therefore, be copied efficiently on so-called short wave receiving sets. An exception is the nightly telegraphic broadcast from the government station at Washington, which includes time signals, weather reports and press news, all on a 2,500-meter wave length.

Interference

The greatest difficulty experienced in radio communication today is due to various kinds of interference. Interference may be caused by other radio signals, by induction from nearby electric power lines, by arc lights, motors or generators with sparking commutators, or other electrical appliances, or it may be caused by natural atmospheric discharges, called "strays" or "static."

The first type of interference, that due to other radio signals, may be lessened by the employment of selective receiving sets. Such interference is gradually decreasing, as the relatively more efficient, sharply tuned continuous wave transmitters and radio telephones are replacing the more inefficient, broadly tuned spark transmitters. In addition, as a matter of courtesy to the many receiving stations, many amateurs are refraining from all transmission during the

evening hours when distant radio telephone "broadcasts" can be heard.

Interference from electrical induction may often be avoided by proper location of the receiving antenna; the aerial is preferably erected at right angles to and as far away as possible from high voltage electric lines. Interference from other electrical devices can often be minimized or eliminated by the prevention of sparking at brushes and contact points, or by the electric screening or shielding of the troublesome apparatus.

Atmospheric electrical disturbances present the greatest difficulty, especially during the summer months. No generally satisfactory and applicable method of static elimination has yet been devised. Some relief is afforded by selective tuning, and by the use of regenerative detector circuits. The development of radio frequency amplification, in connection with special types of receiving antenna, promises some improvement, but is as yet not sufficiently perfected for general use.

RADIO TOPICS, thousands and thousands of copies, every month go to every corner of the globe. Newsdealers in every city, town and hamlet in the United States sell it, and it seems that the more we publish the greater the demands.

Our present and future problem will be to publish articles that a majority are interested in. Where can we improve—and what do you want?

Authors, writers and station owners are requested to submit high grade material which, if up to standard, will be paid for at space rate.

Daylight Range, Night Range

By "normal range" of a radio telegraph or telephone transmitter is generally meant its dependable daylight range, under unfavorable conditions (local lightning storms excepted). Under favorable atmospheric conditions signals carry considerably further. At night, ranges of many times the normal daylight range are often attained. An explanation of this phenomenon appears to be the ionization of the air, which is rendered more conductive by the sunlight, thus conducting the waves to earth instead of permitting their free propagation.

Difference of Location

Geological conditions and other factors not hitherto explained appear to have some influence on radio signals. Some locations appear to give better results for radio transmission and reception than others, without any obvious reason.

"Fading" of Signals

At night-time it sometimes occurs that signals from distant stations "swing" badly, or vary in intensity from one moment to the next. They may gradually become weaker, and even fade out entirely, and then reappear with varying intensity. This phenomenon is known as "fading" or "swinging" of signals, and is believed to be due to certain conditions of the atmosphere. Stations within reliable daylight range are seldom or never observed to fade appreciably. If signals from various stations heard ap-

pear to fade or swing simultaneously, the receiving set should be suspected; in this case the cause is frequently an exhausted filament or plate battery. The condition of the "A" (filament) battery is indicated by the filament brilliancy attainable or with a storage battery hydrometer, while the "B" (plate) battery units are tested by means of a voltmeter, and should be replaced if the voltage per unit does not come within one volt of the normal value. An irregular hissing or frying noise is frequently another indication of an exhausted "B" battery.

U. S. RADIO REGULATIONS

License

No license is required for the operation of receiving sets. For the operation of radiotelegraph or radiophone transmitters, the United States Radio Regulations require two licenses, namely, a station license and an operator's license. Operators of amateur stations must possess a receiving speed of at least ten words per minute continental Morse code, five letters to the word, and must possess a knowledge of the adjustment and operation of their instruments.

Secrecy of Messages

The nineteenth regulation, of the act of Congress to regulate radio communication, approved August 13, 1912, provides a heavy penalty for divulging the contents of any message transmitted or received by a radio station, except to the persons to whom the message is directed, or to their authorized agents, or to another station employed to forward the message to its destination.

Broadcasted messages, in telegraphy denoted by the prefix QST, are addressed to all stations and, therefore, are common property. These may be passed on as the receiving station desires, unless a special restriction is added to the broadcasting prefix by the transmitting station, such as, for example: "QST to all ships subscribing to Marconi news service," or a similar restriction.

Radio Inspector

The complete pamphlet, "Radio Communication Laws of the United States," is obtainable from the Superintendent of Documents, Government Printing Office, Washington, D. C., for 15 cents per copy. (No stamps.)

Requests for license application blanks and similar correspondence should be addressed to the U. S. Radio Inspector in charge of the district. The offices of the radio inspector for the Ninth District are 429 Federal Building, Chicago, Ill. This district comprises the states of Wisconsin, Indiana, Illinois, Michigan (upper peninsula only), Minnesota, Kentucky, Missouri, Kansas, Colorado, Iowa, Nebraska, South Dakota and North Dakota.

RADIO TRANSMITTING EQUIPMENT

Complete radio transmitting sets are on the market at various prices. A complete spark or continuous wave telegraph transmitter may be assembled by the experienced amateur at a cost of \$100 or more, depending on the range to be covered. Owing

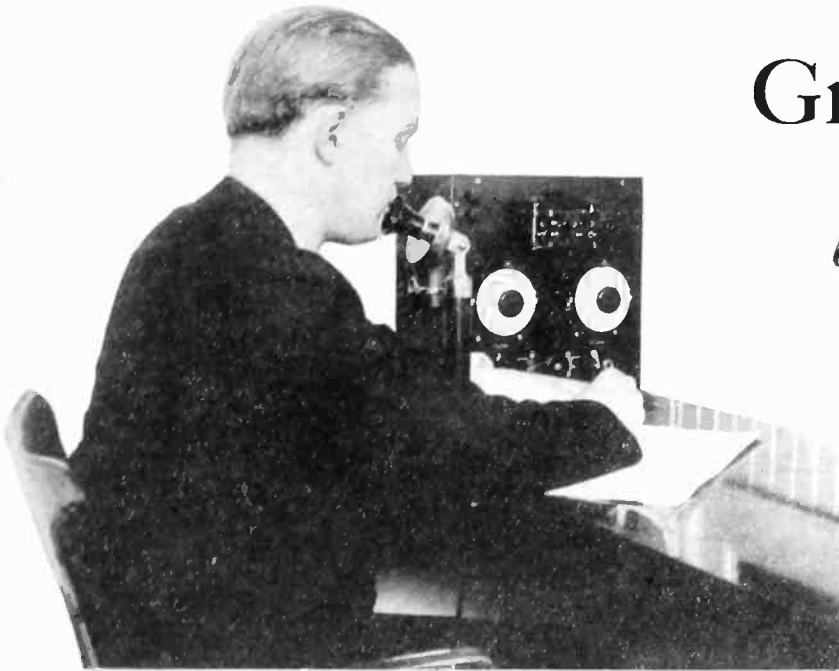

Grain Markets by Radiophone

By ROBERT H. MOULTON

The stock reports are transmitted over land wire to the radio station, from where they go out to thousands of receivers in all parts of the country.

EVERY second counts in grain broker's offices when it comes to flashing quotations to customers, and to country grain dealers. Heretofore this has been done by telegraph or by ticker service; the latter in particular has for a long time been the chief medium of disseminating price quotations and general market news. That this time-worn system of communication may be in danger of being shelved in the not distant future is indicated by the action of the Chicago Board of Trade. The Chicago exchange, the largest and most important in the world, is now broadcasting by radio its quotations and market news of importance at half hour intervals, beginning with the opening of the market at 9:30 a. m., during the hours of each business session.

The Board of Trade is making use of the KYW radio station of the Westinghouse Electric & Mfg. Co., whose aerials are on top of the Commonwealth Edison Building. So far 807 receiving stations have reported reception of the information disseminated. Transmission is accomplished by means of a private wire connected directly to the radiophone, so that when the operator on the floor of the exchange speaks the set is operated direct. The board is now contemplating the installation of a permanent and powerful station of its own, and when the service has been perfected in this manner it is not unreasonable to expect that it will be possible for the grain dealer, wherever located, to have his market quotations with his golf game or when on a fishing trip, just as he now has his newspaper to read at the breakfast table, and that the farmer in the field can reach up in the air above him and, with the proper kind of "ears," learn exactly the latest prices of the principal grains in the leading markets of the world and to keep in constant touch with the vari-

ous factors that influence the effect of supply and demand upon grain values and allied products. The board's limited use of the radio already has resulted in bringing the Chicago market even closer than ever to producers, dealers and handlers of grain.

All that the farmer and the country grain dealer needs to do to obtain the radiophone quotations is to install the necessary equipment, tune to the proper length, and listen. The country elevator offers a very good support for the aerials, which can be stretched from an insulated hanger at the top of the cupola to a similar hanger on the office or to any adjacent building of equal or greater height. The aerial should have no effect on the lightning hazard of the elevator, because the main wires will be insulated

from the building itself. But if it is desired to make doubly sure the hanger itself can be grounded the same as any other lightning rod. The active wires of the aerial must not be grounded, of course. They are connected to the instrument and must be free to transmit to them the electrical impulses taken from the air.

Getting market quotations and news is, of course, not all that the country dweller receives. In the evening the grain dealer's family may repair to the elevator and "listen in" on musical programs, grand opera, the latest news flashes, and what not. Or he can install a radiophone set in his home. All the individual has to do is to hang his aerial wire, attach it to his receiver, and anything he picks up is his, free of charge.



It was previously customary for a broker's office to have a telegraph operator, but now he employs radio and gets his reports hot off the board.

Variometer or Coupling Coils

Small Pancake Coils are Used on this Variometer to Replace the Usual Ball Types

THE design of the coils for the variometer described in this article is not greatly superior to the ball and hollow winding types, but it offers some new thoughts for the experimenters and a different method of making a simple variometer where winding forms for the usual sort are not available. Actually this variometer is a modification of the figure 8 windings, in that the two halves of the figure 8 coils are replaced by two circular coils wound in opposite directions. Fig. 1 shows the front of the completed instrument and, at the right, sectional views of the device employed in winding the pancake coils. Fig. 2 illustrates the appearance of the rear and side of the in-

which would be self-supporting and would not be damaged during work of assembling the parts, and, second, how small wire could be without rendering the coil too secure. The latter factor is important, for the size of the coils is limited and it is necessary to use small wire in order to obtain a fair amount of inductance. Otherwise, with too small an inductance, this type of winding would not be practical. As a matter of fact, it was found that No. 26 S.S.C. wire could be used without involving any great difficulties.

The winding form, Fig. 1, is made in two parts, a main section which is put in the chuck of the lathe, and an end plate held by a center in the tail

ference of the protruding face. A pin was then driven into the end plate and the hole in the main section drilled out so that the pin slipped in easily when the parts were assembled.

To wind the coil, the main section was fitted in the chuck, the end plate, with its pin in place, set against the face, and the tail stock moved up so that the end plate was held firmly against the main section. Then a fine wire was held in the saw cut and the winding started by putting the end of the wire through the slot in the end plate. As the winding progressed, the fine wire was pushed into the cut. When the groove was full, the fine wire was brought around and twisted so that the coils could not unwind.

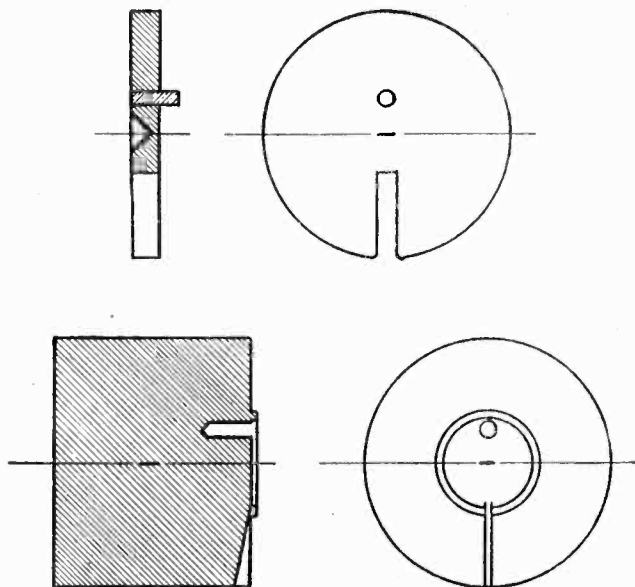
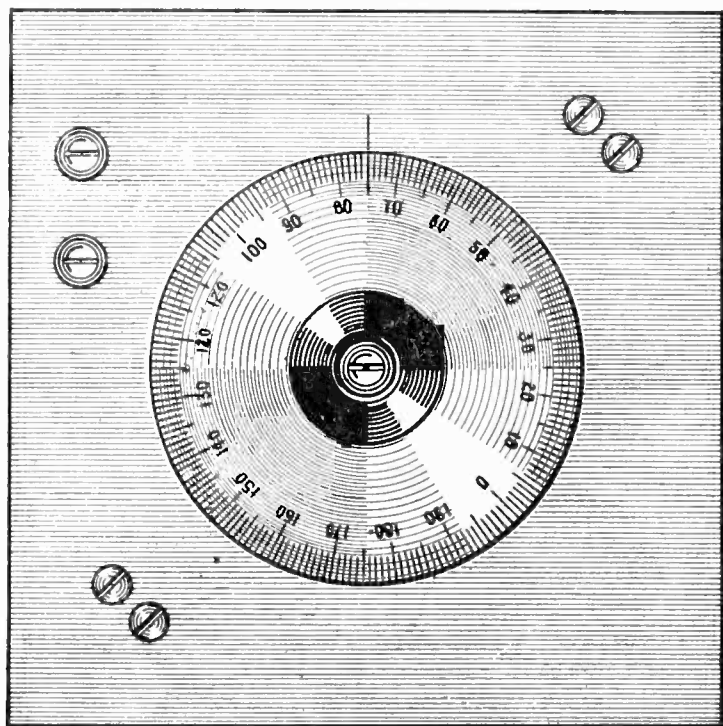

Fig. 1, left.—The front of the panel of the completed variometer. Right. Cross sectional views of the form used for winding the coils

strument, while in Fig. 3 there is a wiring diagram.

Essentially, the variometer is made up of a set of stationary coils in front of which another set is rotated. For experimental purposes, a 360-degree scale was used, divided into 200 parts. However, only one-half a revolution is needed to pass from minimum to maximum, so that a scale of 100 divisions, 180 degrees, is sufficient.

The coils are the most interesting and the only difficult part of the instrument. A number of experiments were made at the Everyday Engineering Laboratory on windings of this sort to determine first, if it was possible to make up a small pancake coil

stock, and pinned to the other section. The form used for this work was cut from brass rod $1\frac{3}{4}$ inches in diameter. The face of the main section was first turned true and smooth. Then it was cut back the thickness of the wire and turned down to three-fourths of an inch. The slight ledge on which the wire was wound was turned at an angle of 45 degrees to the face, and the protruding face was slightly counter bored and a saw cut made as shown in the cross-sectional views. The end plate is merely a washer with a slot cut in five-eighths of an inch. This work done, the two parts were put together with the slot of one opposite the saw cut in the other, and a hole drilled just inside the circum-

Cutting off the wire and bending the end backward completed the coil.

The next step was to push back the tail stock and withdraw the end plate. Just a touch on the binding wire and the coil slipped off the face of the main section. Finally the coil was dipped in very hot beeswax. After cooling, it was found that the coil, though wound with No. 26 wire, was quite strong and firm.

The next step in constructing the variometer was to cut out a bakelite strip 5 inches long and $\frac{3}{4}$ inch wide, to act as the support of the stationary coils and a bearing for the shaft which controlled the movable coils. The strip was drilled, as shown in Fig. 2,

for the screws, the shaft, and the holes through which threads were passed to bind the coils in place. Four more holes were drilled to take the terminals of the coils. They were made

during the soldering process. It was found, however, that since the binding threads were near the terminal points, they held the wires well enough so that, although the beeswax

employed at the front. This is not necessary because only a half-revolution is required to pass from a maximum negative mutual inductance to a maximum positive mutual. The panel measures 5x5 inches, and, to insure sufficient strength, should be 3/16 or 1/4 inch thick.

This type of variometer can be used as a coupling coil by connecting the windings as shown in Fig. 3. Then four binding posts will be necessary, two for the coils acting as a primary coupling inductance, and two for the other set of coils serving as the secondary coupling inductance. Again, this can be used as a secondary coupling and tickler coil.

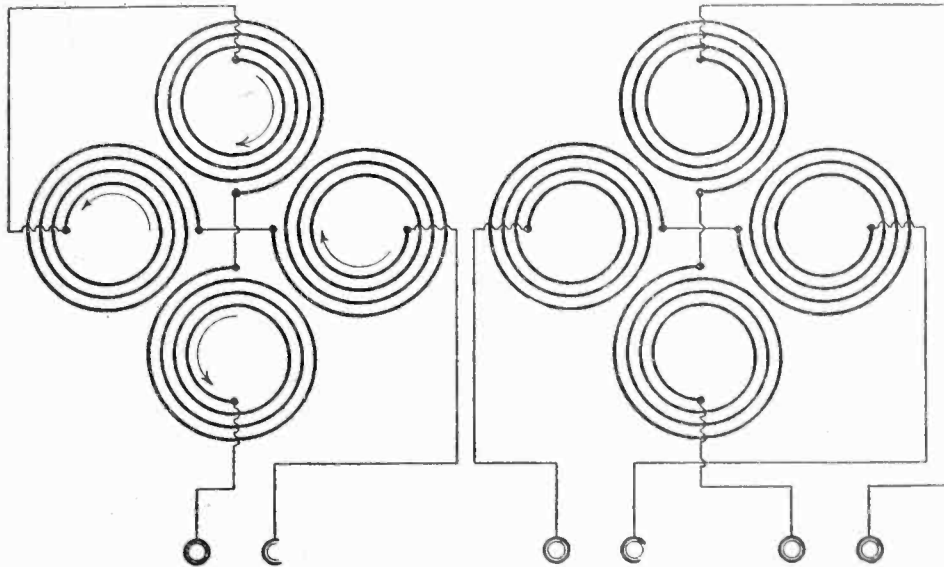

Fig. 3.—At the left, the connections for a variometer. On the right, a diagram for coupling coils

fairly large to allow for variations in the position of the terminals. It will be seen that the ends of coils are bent back squarely. This was done by holding the coil with a parallel jaw pliers while the wire is being bent. Otherwise, the turns would have come loose. The coils were 2 1/4 inches apart, center to center. Another strip four and one-eighth inches long and three-fourths inch wide was cut out to carry the movable coils. These were fastened on in the same way.

At this point, flexible leads were soldered to the terminals of the coils. It will be readily understood that considerable caution was necessary to prevent the coil from coming apart

became soft, the turns did not come apart. A very hot soldering iron was used, so that just a touch was necessary to make the joint.

Details of the assembly are given in Figs. 1 and 2. The bakelite strip for the rotating coils is held by a nut against a 3/8-inch length of 1/2-inch round rod, which is, in turn, locked by a second nut. Two washers were put on at the rear nut to act as spacers, so that the movable coils were held 1/16 inch from the stationary coils. A washer and lock nuts on the end of the shaft kept the movable section in place.

It will be noted that a 360 degrees scale divided into 200 parts is em-

Ship Operator Sends "Kidding" Messages as Vessel Sinks

"We are sinking fast—stern first—can't hold up much longer—the skipper just dictated that, and he ought to know—where did I put my hat—sorry, we can't wait any longer—have a pressing engagement with Davy Jo—" These were the last words to be flashed by radio from the ill-fated Norwegian steamship Grontoft, whose wireless operator jested with death as the water engulfed his apparatus. The message, as written above, is recorded on the log of the steamship Ethonia, which reached the scene of the disaster some time after and reported, "No trace of wreckage." The engagement with Davy Jones was kept.

Harvard to Send News

A radio news service has been planned by the Harvard Wireless Club of Harvard University. An effort will be made to co-operate with other colleges in the broadcasting of intercollegiate news of interest to students and alumni. The club has a set capable of transmission in a 500-mile radius and can receive any broadcasting station east of the Mississippi River. It is hoped that the colleges may exchange football scores during the coming fall season.

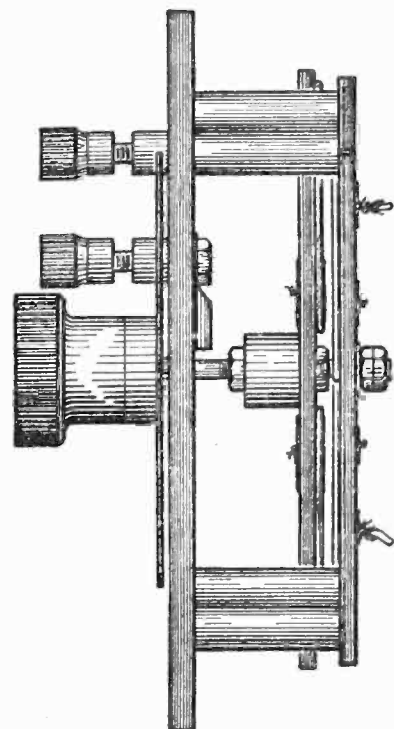
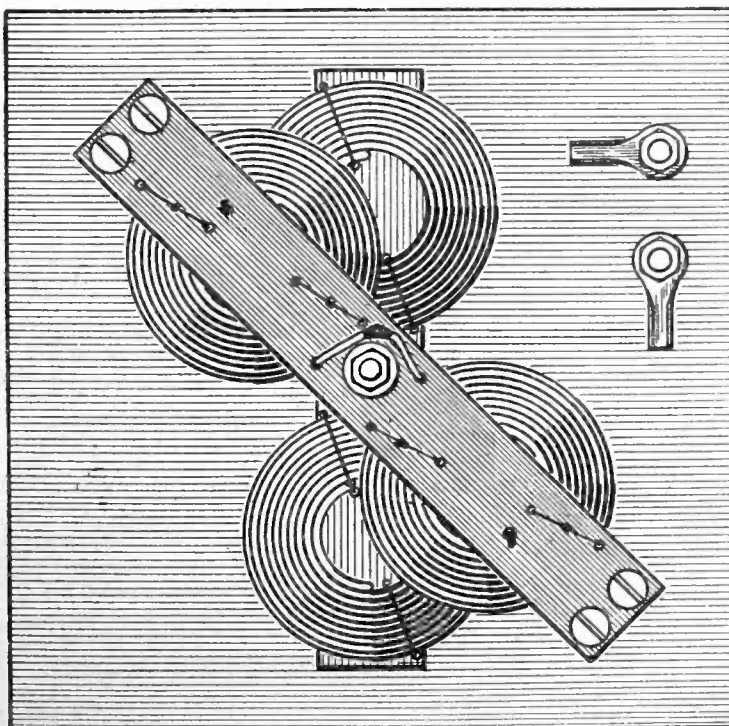

Fig. 2.—Rear and side views of the instrument as it appears when finished, except for the connecting wires

We have read many thrilling news accounts, but this graphic description of a recent test on the Lackawanna railroad surpasses them all.

The Radio Limited

By J. J. GRAF

Telegraph, Telephone and Wireless Engineer, Delaware, Lackawanna & Western Railroad Company.



ON Wednesday, April 5, the Lackawanna Railroad Company operated a special train to carry students from Cornell College at Ithaca, N. Y., to New York City, a distance of 265 miles. The students were home bound for the Easter recess. The train was equipped to transmit and receive wireless signals, both telegraph and telephone.

Mr. L. B. Foley, superintendent of telegraph, telephone and wireless of the Lackawanna Railroad, was given the assignment to install the necessary apparatus on March 16. Great difficulty was encountered in securing practically all of the equipment because of the great scarcity which has prevailed since broadcasting has created such a popular demand for all radio apparatus.

Fortunately, however, co-operation was obtained from several young men whose achievement stood out prominently during amateur trans-Atlantic tests about two months ago, and with their assistance a variety of exceptionally efficient apparatus was obtained; also a transmitting outfit, which will be described as the narrative progresses.

A buffet car was selected for the installation. This car is of modern steel construction with a small baggage compartment at one end, wherein were installed the motor generator and transmitting unit; also a spare set of car lighting batteries were installed on the floor for emergency service in the event of a failure of the regular car unit.

A three-cage antenna was installed directly over the car, one on each side and one in the center; the clearance between antenna and car averaged fifteen inches and was determined by maximum loading clearances of a tunnel through which the train would pass. The cages were made up of six No. 14 B. & S. G. stranded copper conductors, using 4½-inch copper wire rings for spacing and forming, and were supported horizontally from 1½-inch conduit pipes fitted with attachments, which in turn fitted the regular marker sockets of the cars. A dining car assigned to the train and lined up preceding the buffet car was also equipped with antenna for the purpose of obtaining maximum radiation while transmitting. Its use for reception was not required. No difference in signals were noticeable, with one or both antennas.

The transmitting unit consisted of a motor generator, motor operating on 12 volts DC and generator developing

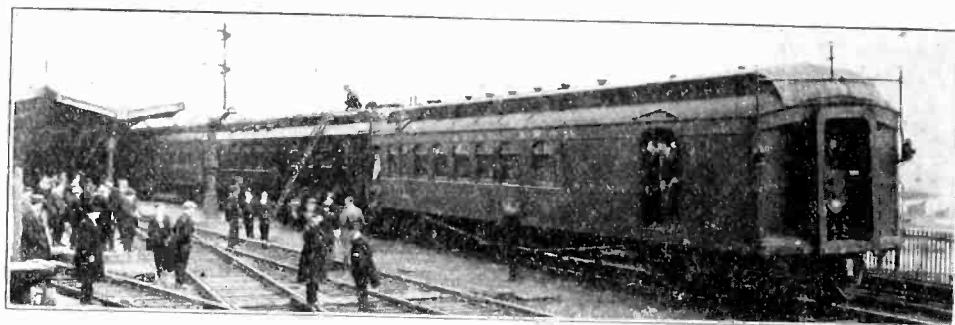

Radiophone tests were conducted on this Cornell Special of the Lackawanna Railway, a three caged antenna being installed in the buffet car. During the entire run of the train communication was maintained with a number of amateur stations, and special programs were received from two of the broadcasting stations.

300 to 350 volts. Three five-watt power tubes, shunted with an ordinary high resistance transmitter, represented the modulating elements. The transmitter, mounted on an ordinary desk stand, was located on one of the alcove tables in the passenger compartment of the car. The ordinary switch hook was removed and substituted with a special push button, which controlled the motor circuit as well as the antenna switch, resulting in almost ordinary operation of a regular telephone conversation. The wave length control condensers were mounted on a small panel, which also supported the customary volt meter, modulating indicator and antenna ammeter. Radiation never exceeded 7/10 of an ampere. The natural wave length of both antennas coupled was 275 meters.

The receiving apparatus required considerable experimenting. If it had been the intention to use head receivers no difficulty would have been experienced. Realizing, however, the Cornell Special would carry an exceptionally large number of passengers and because of the unusual interest manifested in radio since the inauguration of broadcasting service, it was determined to use loud speakers if it could be done. This necessitated amplification of decidedly large quantities. This was easily obtainable while the car was standing, but when in motion, although quantity was easily maintained, quality suffered greatly, due principally to mechanical vibrations affecting the plates of the tubes.

This condition proved troublesome, and I feel that we should have had to abandon loud speakers had Mr. M. R. Davis of the Magnavox Company not come to the rescue late Tuesday afternoon with a type AC-2 Magnavox Amplifier. This instrument has two

stages of power amplification and immediately made reduction of audio amplification possible, which greatly improved the quality of received signals and broadcasted entertainment.

The cars left Hoboken, N. J., at 7:20 p. m. April 4 empty, and while traveling to Scranton, Pa., a distance of 140 miles, all of the principal broadcasting stations east of Detroit were heard distinctly all over the car, using only one stage of the Magnavox power amplification. When the train stopped at stations the music apparently was easily heard by people within considerable distances of the station and crowds congregated quickly. A rather unusual incident occurred while running between Hackettstown and Washington, N. J., about 55 miles from New York. The writer from the inception of the project had been unable to work up any great enthusiasm over the venture for the reason that so little entertainment circulated during the day, also because of the vast difference in reception during the daylight hours as compared with night. He discussed the matter several times with Mr. Foley, and the latter communicated with the Westinghouse and General Electric Companies, suggesting something special for the occasion. No word had, however, been received from either company when the train left Hoboken.

When we reached the point mentioned we were in the act of tuning away from a persistent CW amateur and struck Schenectady, who was just announcing that they had prepared a special program for the following day for Cornell Special, equipped with radio.

This was certainly happy news, and our appreciation was expressed in various manners, both vocally and physically.

After the cessation of the broadcasting stations we logged amateurs from Halifax, Pawtucket, to Florida and as far west as Minnesota, also an amateur telephone in Rhode Island.

The cars arrived at Ithaca at 8 a. m. and were immediately switched into their assigned position in one of the specials. A large number of the boys were already at the station awaiting our arrival. They explained that they wanted a lot of time and sufficient elbow room to inspect the equipment, which later proved good judgment. Communication with the Cornell College radio station was almost immediately established and maintained

through Hallstead, Pa., fourteen miles east.

By this time the students manifested considerable impatience. These practical demonstrations of what could be done with such a small amount of power were of great interest to us, but the superior intelligence of college students is apparently quick of perception, and demonstrations need not be unduly prolonged.

We again tuned to 360 meters and found Schenectady rendering a very beautiful soprano solo and did not again attempt to interrupt the performance until it was suggested by the students themselves. There were on

By this time the students had virtually taken possession, chairs were removed and the dance was on.

The writer had never before met COEDS, and the word or term or whatever it is had never meant anything to him. However, after his introduction to the inspiration of the five letters he wants to subscribe to everything that has ever been said of them, which has always been nice, particularly of the species that grow at Cornell. Roses, you know, develop to their greatest perfection in California, and I am sure that COEDS are more beautiful at Cornell than they could possibly be anywhere else.

The train reached Hoboken, N. J., at 7:35 p. m., exactly seven hours en route. The distance from Ithaca is about 272 miles. Three mountain ranges, one of 900, the other of 1,600, and the third over 2,000 feet elevation, were crossed. I am only mentioning these details to give the reader an impression of the great speed it was necessary for the train to make, when grades permitted, to cover the distance in the stated time. No doubt you are familiar with the usual train noises associated with such speed, which will give you a fair idea of the remarkable volume that was obtained from the radio apparatus.

G. Donal Murray, David Richerson and Theodore Sisson are the three young amateurs referred to early in this narrative. These young men were among the few who succeeded in transmitting signals to Paul Godley in Scotland about two months ago. They handled the apparatus at Princeton College, the greater portion of which they had made themselves. In view of the fact that plants of the Radio Corporation and the government to accomplish the same purpose represent an expenditure of millions of dollars, this accomplishment was a distinctive achievement, although it is



The Cornell Jazz Orchestra played a number of selections over the transmitter on the train, the music being reported at a distance of over forty miles. Only three five-watt tubes were used as transmitters and the Magnavox horn was employed to act as a collector of the orchestra music.

until the train left the city at 12:35 p. m. and continued for about fifteen miles, when we tuned in Schenectady. This was accomplished without difficulty, the first selection being a piano solo, reception very loud and perfect quality. Careful adjustment of the filament rheostats enabled us to use both stages of power amplification in the Magnavox, after which the roar of the train, comments and conversation among the students, with whom the car was continually packed, in no way interfered with the music, vocal and instrumental, or conversational announcements. In fact, the entertainment was easily heard in the adjoining dining car.

After about one-half hour's entertainment Schenectady announced a short intermission, which we took advantage of to send out some Q S T's. An immediate response was received by code from Raymond Strong, living at Owego, N. Y., six miles south of the train's position. We exchanged a number of messages with him without the slightest trouble and continued to gossip for the next twenty miles, when we heard another spark calling. This proved to be Leo Mills, at Endicott, N. Y. He explained that he lived six miles north of the railroad, and seeing the train pass through, with the aid of field glasses, thought he would run in and try for contact. He seemed overjoyed when it was accomplished.

Just before reaching Binghamton, N. Y., we heard the first radio telephone call from A. L. Kent, who lives there. Mr. Kent's cheerful greetings came to us loud and clear and were easily understood by everybody in the car. We again exchanged messages and gossip until the train was passing

board several members of the Cornell Jazz Orchestra, and they wanted to know if we could broadcast several of their popular selections. We thought we could. The horn of the Magnavox was impressed to act as a collector and bang, the show was on. The music was certainly good and was heard perfectly by Roy Ehrhardt, Major Stanley Dolph, Russell Wide-

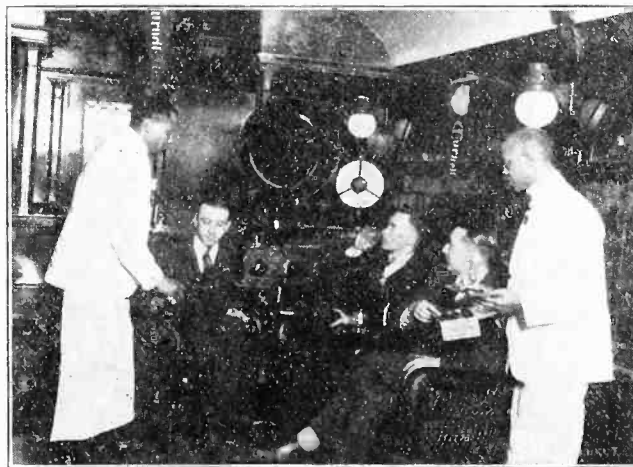

Mr. Murray, Richardson and Hert were apparently well taken care of and put in good spirits previous to their night run to Ithaca after having completed the installation.

mer and Walter Gerrity, who were listening in at Scranton, Pa., over a distance of forty miles, and we were told at Stroudsburg, Pa., that it was heard there all the way down the Pocono Mountains.

After leaving Stroudsburg we picked up the Westinghouse station and the Bamberger department store stations at Newark, N. J., and the Wanamaker store in New York City.

only another demonstration of a radio amateur's ordinary persistence.

From a historical standpoint this test and its results are but a repetition of what was performed on the Lackawanna in 1913, when similar experiments were performed and successful to the fullest extent of the art as it had developed to that time. However, none of the results of that

(Continued on page 33)

RADIO TOPICS

The National Radio Monthly



FOUNDED 1921

PUBLISHED EVERY MONTH BY

RADIO TOPICS, Publishers

1112 North Blvd.

OAK PARK, ILLINOIS, U. S. A.

NORMAN E. WUNDERLICH, EDITOR

PUBLISHING AND
EDITORIAL OFFICES

Chicago Fone: Austin 9300
Oak Park Fone: Oak Park 6000

CHICAGO ADVERTISING
OFFICES ONLY

108 S. La Salle St.
Chicago Fone: Dearborn 2680

Twenty Cents the Copy From All Newsdealers. By Subscription: To the United States and Possessions, Cuba and Mexico, \$2.00 the Year. Remit by U. S. Money Order, Express Money Order, Check or by Draft, payable in U. S. Funds.

To Canada—By Subscription, \$3.00 the Year. Single Copies 25 cents—Canadian or U. S. Funds.

RADIO TOPICS is on sale the first Wednesday of each month. Manuscript and advertising forms close the 22nd of month preceding issue.

OAK PARK, ILL., MAY, 1922

OUTLAW MANUFACTURERS

BUSINESS conditions continue to be about the same with little material available, in spite of the fact that most of the manufacturers had contemplated being caught up by this month. Apparently the number of people interested in radio is increasing at the rate of over 10,000 every month, with fruitless efforts being made to catch up on production to meet the new demands. Practically every newspaper and magazine in the country is devoting some space to radio these days, and every class of merchant is becoming a radio dealer. The field is fertile, and those with an eye for business are conceiving every imaginable scheme to procure money from the freely spending radio public.

Just as during an oil boom, which is accompanied by dozens of fake promotion schemes, so with the radio, where we now find fakers, profiteers, wildcat promotion schemes and last, but not least, the outlaw manufacturer.

This latter is the illegitimate user of patent rights, the famous Armstrong patent now being used by hundreds of people who are without the necessary patent license, as well as many of the other patent rights, including those of the three element vacuum tube.

Those that are making and bootlegging, to use the nationally known expression, regenerative receiving sets and vacuum tubes figure that they can produce a sufficiently large number to enable them to clean up a large amount of money before they are apprehended. And some of these people are succeeding quite well by employing various underground methods of distribution for their

products. Said one of these outlaw manufacturers to us the other day: "The radio public will buy anything these days; the regularly advertised manufacturers cannot supply the demand. We can supply a large quantity of sets, get a good price, clean up a tidy sum and pull out."

That is just where the danger comes in. These people are turning out inferior apparatus at a fast rate, with no guarantee and without any effort to make good apparatus, their only desire being to get some money and clear out. It is a dangerous game they are playing. The prospective buyer will do well to sidestep anything but standard, advertised apparatus. The outlaw manufacturer is undesirable from every angle. He will not advertise, for he dare not do so. Dealers who sell his products will find many complaints upon their hands, and, furthermore, the dealer is just as liable as the manufacturer to prosecution for infringement of the patents.

We want this radio field to be just as clean as it is possible for it to be, and there is no reason why it cannot be just as upright as the electrical or motor industry. There has been much said about an attempted monopoly, trade restrictions, etc., by the larger corporations. That the majority of the important patents are held by a single combine is well known. They came to possess these patents by an honest purchase, and they are apparently attempting to supply the demands for apparatus. Whether or not they are holding vacuum tubes in their warehouses for future use with their own apparatus rather than filling their dealers' orders, whether or not they are making unjust demands of the seventeen holders of Armstrong patent licenses, if they are refusing to issue any further licenses to manufacturers desiring them, or if they are refusing to sell others desiring them complete broadcasting stations, we are in no position to say. We doubt that there is any foundation to these rumored accusations, but these questions will all be settled through a Congressional investigation recently instigated by Mr. Brittain of Illinois.

In the long run it pays to be honest in business. The manufacturer who makes apparatus that he will back up for all time to come, trades above board and establishes prestige for his concern through consistent advertising is the one to be respected and is the one who will continue to forge ahead in business.

THE CHANGING WORLD

The people of this generation have seen so many new and startling inventions spring up that they were just beginning to become hardened to such things, passing over such news with the comment, "Well, what do you know about that!" but when the realities of radio telephony were brought home to them they began at once to see the unlimited possibilities of its commercial use.

At the first national radio held in Chicago last year it was impossible to bring the people in to the exhibits. Today the show promoters spend their time worrying how they can handle the crowds. Six months ago the number of persons following radio was somewhere under the fifty thousand mark. By fall of this year they will number one million. There were not over two hundred manufacturers and dealers in the country, whereas today they total close to three thousand.

Every day a new practical suggestion is made for the use of radio telephone. Tufts College is about to start a series of instruction courses to be broadcasted by radio-telephone. The students may stay right at home and mail in their papers for examination. Yacht clubs are installing transmitters and their members are installing receiving sets on the boats. Numerous vehicles are being Police, fire departments and patrol boats are using radio-phones for many purposes. Candidates in the next national election are planning to campaign via radio. Dances are being furnished music, and restaurants and cigar stores are receiving the baseball reports. Everybody asks "What next?" Who knows?

Radio Equipment

Immediate Delivery

We are equipped to manufacture the following Radio parts:

- | | |
|----------------------------------|----------------------------------|
| C. W. Transformers | Rotary Spark Gaps |
| Choke Coils | Condensers |
| Modulation Transformers | Microphones |
| Filament Heating
Transformers | Motor Generators |
| C. W. Inductances | Rheostats |
| Audion Control Panels | Amplifying Transformers |
| Variable Air Condensers | Variometers and
Variocouplers |
| Grid Leaks | Loud Speakers |

We have exceptional facilities for manufacturing small screw machine parts.

Send in your blue-prints and specifications.

The Dayton Fare Recorder Co.

DAYTON, OHIO

BRADLEYSTAT

PERFECT FILAMENT CONTROL

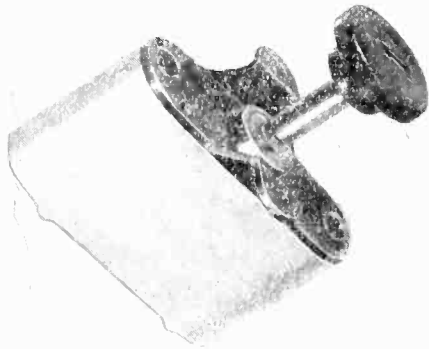

The latest contribution of science to Radio is the Bradleystat with its stepless and noiseless current control for detector and amplifier bulb filaments. It is the application of a well-known principle to a new field, and the results in better detection and amplification are amazing. 10,000 Bradleystats are used each week to replace wire-type rheostats. Send for bulletin.

Price **\$1.85**
Add 10c for P. P.

Allen-Bradley Co.

289 GREENFIELD AVE., MILWAUKEE, WIS.

RADIO PHONOGRAPH CABINETS

WE MAKE TO ORDER
Radio Phonograph Cabinets, Radio Cabinets and Boxes per your specifications, in 100 or 100,000 lots.

Let Us Figure Your Wants
QUICK DELIVERY. Samples can be seen at our factory.

National Phonograph Co.
2813-25 N. Ashland Ave.
LAKE VIEW 1191 CHICAGO

MAILING LIST

2500 Radio Dealers\$20.00
116 Radio Manufacturers 3.00
Ask for General Price List No. 109
for all other lists
Trade Circular Addressing Co.,
166 W. Adams St. Chicago, Ill.
Phone Franklin 1182



RADIO
Complete Stock
Open all day and
every evening
Apex Radio Co.
Inc.
1105 W. 69th St., Chicago, Ill.

DO YOU TAKE ONLY "HALF WAY" PRIDE IN YOUR RADIO WORK?

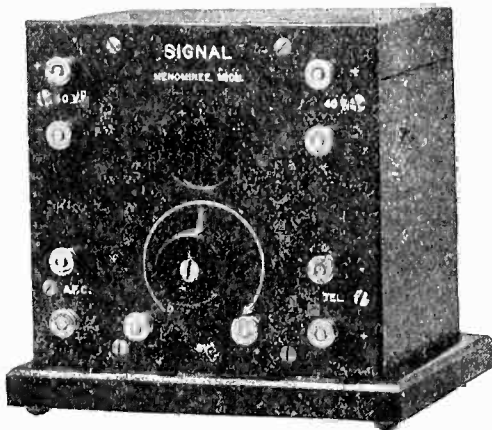

It is impossible for the radio-electrician—professional or amateur—to take real pride in his work with inferior or "half way" instruments. Whether in the first-grade—or taking a "P. G." in the great School of Radio, you owe it to yourself to be particular to the point of "fussiness" over your equipment. Consult Radio experts, teachers and students who KNOW about

"SIGNAL"

Then check up Signal WIRELESS APPARATUS with other makes, price for price, feature for feature. If you do this your choice will invariably be—"SIGNAL."
Write us today for literature, names of users and nearest distributor.

Signal Electric Manufacturing Co.
MENOMINEE, MICH.

EVERYTHING FOR THE RADIO NOVICE AND PROFESSIONAL

RU

INTERESTED IN
SCIENTIFICALLY DESIGNED
RADIO APPARATUS?

ESTRU

Lattice Variometers
List Price \$5

Lattice Variocouplers
List Price \$4.50

Are a development of months of careful study; small, compact design; no unnecessary framework; maximum efficiency by lumped inductance; low distributed capacity; sharp tuning; ideal for portable sets.

Manufactured By

Dalton, Whittier, True Co.

2905 West Madison Street
CHICAGO

DEALERS—JOBBER
AND LARGE USERS OF

CRYSTAL SETS

We are in a position to make your outfits cheaper than you can yourself. We make every part, so can talk price. Immediate delivery.

We feature a set that measures 3 in. by 4 in. by 5 in. For price write, wire or call

WIZARD RADIO CO.
1014 Century Bldg., Chicago

FROST FONES

SOLD EVERYWHERE
HERBERT H. FROST
154 W. Lake St., Chicago

RADIO

Equipment

Big
FREE
Catalogue

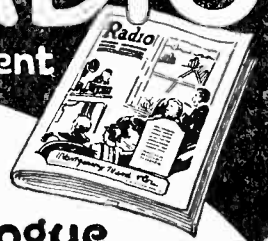

THIS FREE catalogue tells you the kind of a Wireless Telephone to own, so that you receive in your own home all the latest news, music, church services, lectures—everything broadcasted throughout the United States.

Every home will soon have a wireless telephone outfit. We now offer complete outfits from \$15 up.

Everyone interested in radio should see our low prices on parts and accessories. Write for this book. Learn about the miracle invention of the age. Easy to install, as simple to operate as a regular telephone.

One copy of this booklet is yours, FREE
Write for your copy.

Montgomery Ward & Co.
Dept. R-3 Chicago

Radio Frequency Amplification

Is Reliable and Most Efficient When Using the

TYPE R-10

ALL-AMERICAN TRANSFORMER

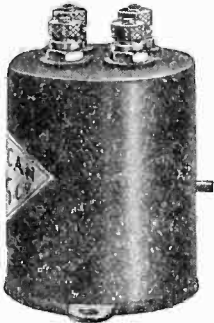

PRICE
\$4.50

at your Dealer

DESIGNED FOR
150-550 M

Immediate Delivery

This transformer, like "All-American" audio-frequency transformers, has gone through a series of tests that has proven its high qualities and standard. It is designed for 150 to 550 meters, being sharp enough for the discriminating amateur and practical for the average layman.

Having a non-magnetic core, it is able to respond to the higher frequencies and properly amplify for better rectification. It is not subject to atmospheric condition, being properly treated and impregnated. These transformers can be used with Radiotrons, Cunningham, Moorehead or Meyer's tubes.

Like the "All-American" audio-frequency amplifying transformers (types R3 ratio 10 to 1 and R2 ratio 3 to 1), they are used as standard equipment by many prominent manufacturers.

"All-American" radio frequency receiving sets—radio and audio frequency amplifying units—will soon be on the market,

EFFICIENCY QUALITY
PRICE

making them supreme

RAULAND Manufacturing Co.

Successors to All-American Electrical Manufacturers

35 South Dearborn St.
CHICAGO, ILL.

ANNOUNCING

The LaSalle Radiophone

"The Last Word in Radio Receiving Equipment"

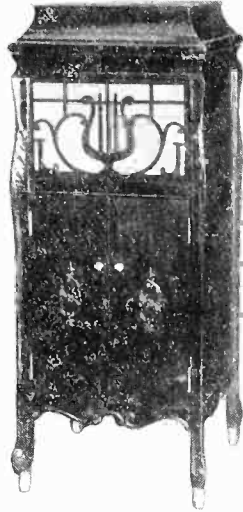

A complete radiophone receiving outfit contained in beautiful phonograph size cabinet.

The Radiophone is a superlative receiving set capable of picking up the broadcasts from all of the high-power broadcasting stations in the country. It will be an ornament to any home and will take its place with the finest furniture.

The Radiophone includes everything and is a complete set in every way. A battery charger is one of the important features. Detector and two stages of amplification are used, insuring a high degree of amplification.

A Console type cabinet can be furnished if desired. Both the regular phonograph type and Console type cabinet will be sold without the apparatus if desired. We also build all types of radio cabinets to order.

Our dealers both install and give service on the Radiophone. If you are contemplating a radio outfit have one of our dealers install a Radiophone and know that you are getting the acme of performance and appearance.

The complete Radiophone sells for \$450. With Console type cabinet from \$600 to \$900.

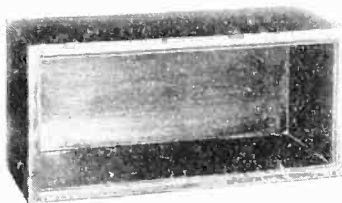

INSIDE DIMENSIONS

For Panel Size	High	Wide	Deep	Mahog. or qtd. oak
6x7	5½ ins.	6½ ins.	6½ ins.	\$3.85
6x10½	5½ ins.	10 ins.	6½ ins.	4.50
6x14	5½ ins.	13½ ins.	6½ ins.	5.50
6x24	5½ ins.	20½ ins.	6½ ins.	7.20
9x14	8½ ins.	13½ ins.	10 ins.	6.75

We furnish Formica Panels cut to cabinet size at an extra cost of 2¼ cents per sq. inch. Dealers and Jobbers, please write for our territory proposition.

RADIO CABINETS

On account of the great demand for attractive stock cabinets of various dimensions we are building them in quantities in our large woodworking plant. These cabinets are all uniform in style. Outside dimensions and inside dimensions are either larger or smaller than the panel itself, so we show panel size and also inside dimensions. Prices quoted do not include panels.

The wood used is either gum or mahogany, in dark antique or red mahogany finish, or in natural quarter oak or antique finish. Please give kind of wood and finish in ordering.

The tops of cabinets are hinged. Sizes and prices as quoted above.

The Chicago Furniture Mfg. Co.

1346 N. BRANCH ST., CHICAGO

UNEXCELLED FILAMENT RHEOSTAT

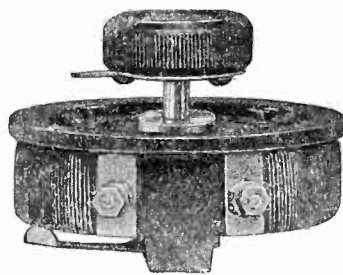

A vacuum tube filament rheostat must be more than a mere current regulator. It must be an instrument mechanically and electrically perfect. To eliminate tube noises the switch blade must make smooth and positive contact.

Our Type 214 Rheostat is made exactly for this severe service. It is made in several sizes, for receiving tubes, for 5 watt transmitting tubes, for grid biasing, and is made for front of panel or back of panel mounting.

Price \$2.50---All described in free bulletin 911T

General Radio Company

Massachusetts Avenue and Windsor Street

Cambridge, 39

Massachusetts

Standardize on General Radio Equipment Throughout

Loop Antenna Practical With Sufficient Amplifiers

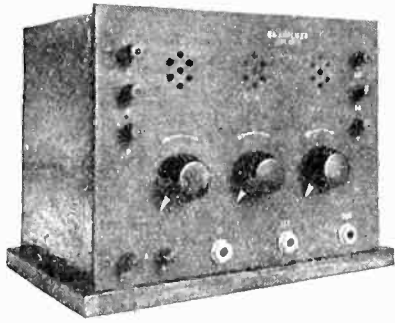

A SUPER-AMPLIFIER FOR WIRELESS TELEPHONE OR TELEGRAPH SIGNALS **DX Amplifier**

Type DX-2, Detector and Two Step, with special amplifying transformers, completely wired, only

\$48.00

IMMEDIATE DELIVERY

Satisfaction Absolutely Guaranteed. Descriptive Folder Sent Upon Request

MANUFACTURED BY

DX RADIO COMPANY, Not Inc.

SUMMIT, ILLINOIS FACTORY, ARGO

"Where Dependable Quality Is Low Priced."

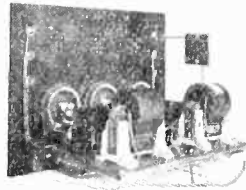

On page 30 in this issue a classified advertising section has been started. You will find this a very effective way of reaching a large number at a small expense.

Specify Radio Apparatus of Quality

Your best guarantee of long and efficient service

REX
RADIO EQUIPMENT
PARTS AND COMPLETE SETS

Meet every quality specification

ASK YOUR DEALER

DEPT. R.

JENKINS MANUFACTURING COMPANY

4607 Ravenswood Avenue

CHICAGO

ILLINOIS

THE outdoor aerial, where it is possible to have one, is, under all circumstances, the better type of aerial to employ. However, there are cases and locations where it is impractical and sometimes impossible to use the outdoor antenna. In these cases with the proper receiving set a loop aerial can be used. The loop aerial, it is well to state here, is not adaptable for use with a crystal detector set or even with a regenerative set using less than three tubes. In cases where one is forced to use the indoor antenna of the loop type there are several things to keep in mind. The energy picked up by the loop is not sufficient when using two steps of amplification to operate a loud speaker in conjunction with the set. It is sometimes very difficult to receive signals sufficiently loud to make them audible in ear phones, and for that reason where a loop aerial is to be employed it is found necessary to add additional steps of radio-frequency as well as additional steps of audio-frequency. It is not advisable to try to get good results with less than two stages of radio-frequency backed up by three steps of amplification. This layout for ordinary use in connection with a loop aerial will be found quite satisfactory for use in the home, but will be found wanting in a large lecture room or auditorium.

The set recommended contained five vacuum tubes, two of the detector type, and three for amplification. The resultant energy imparted by the addition of these bulbs to the ordinary two steps amplifying set is of sufficient intensity to make reception good. Naturally the cost is a little more than that of the simple audio-frequency amplifier, but the advantages of indoor aerial operations more than compensate for the extra cost. One of the great advantages of the use of this set with an indoor aerial is the ability to operate without any possibility of harm during thunderstorms when static conditions are very high. Another advantage of the loop aerial is that it permits directive operation—that is, one may turn the plane of the loop aerial in the general direction of the broadcasting station and exclude by this operation all other stations not in the same line. Then, too, the additional steps of detection and amplification make the instrument highly selective, and practically all interference can be cut out, giving almost perfect reception of the desired signals.

The loop aerial and the equipment necessary for its operation is becoming more and more popular every day. In apartment houses and other places where an outdoor aerial cannot be had the value of the loop is recognized. It is not necessary to stand the loop near an open window or have it on a fire escape or out of a window. It will pick up its signals as easily through a brick wall as it will through an open window.

There is no special trick or knowledge necessary for the construction of a loop aerial, although it can be made works of art to fit into the atmosphere of a room of any period. Examples of this can be seen in many radio supply and sales houses around town at the present time where loop aerials can be bought ranging in size from one foot to three feet square and in everything from mission to Louis XV styles. To make a loop at home it is only necessary to wind about fifteen turns of No. 22 silk or enamel-covered wire around a frame a foot square or more. In winding the wire it would be well to groove the corners of the frame so as to keep the wire equally spaced and the grooves so arranged that wire will not touch itself at any point. The frame should be of wood, bakelite or any nonconductor. Do not attempt to use a steel frame. A pivot stand is not necessary for the aerial. It can be placed on any solid stand so that the whole unit may be moved about, giving the same results as a pivot stand. Suspending it from the ceiling seems like a simple way, but it is difficult to keep the aerial turned in the direction from which one is getting the best results. As we all know, anything that is suspended has a natural direction and when turned from its natural position will return as soon as the diverting force is released. A point to remember in loop operation is that a ground connection is not necessary. The two loose ends of the loop should be carried to the terminals of the receiving instrument, one to the aerial terminal and the other to the ground terminal.



The neat and powerful station shown above has been installed in the Thomas G. Plant shoe factory at Jamaica Plains, Boston. Its signals have been reported at a distance of over two thousand miles.

FORD TO EXPLAIN FLIVVER BY RADIO

Henry Ford is going to tell "flivver" owners of the intricate methods of "flivver" operation by wireless phone. The department of commerce has announced that Ford has been granted permission to operate a broadcasting wireless phone at Dearborn, Mich. His call is WWI.



WE are marketing reliable Radio equipment supplied by the "Old Time Radio Manufacturers" who have made Radio what it is today.

Detroit Electric Co.

Exclusively Radio

113-115 E. JEFFERSON AVE.

DETROIT

SAVE MONEY ON STORAGE BATTERIES FOR WIRELESS USE

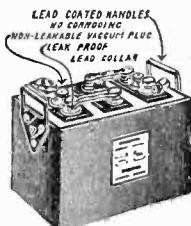

6 volts 40 amp.....	\$ 9.00
6 volts 60 amp.....	13.00
6 volts 80-100 amp.....	19.50

Batteries shipped fully charged, ready for use
GUARANTEED 18 MONTHS ON ADJUSTMENT

If your dealer can't supply you, send check or money order direct
LIBERTY BATTERY CO.
Distributors—Jobbers—Dealers—Write for Discounts
4243 Armitage Ave., Chicago, Ill.

If It's an AETACO Product You Know It's the Best There Is

DIALS

These AETACO Dials are of German Silver, made according to government specifications. They are especially desirable for those making their own regenerative sets. Anti-Capacity Type. Illustrated one-half actual size.

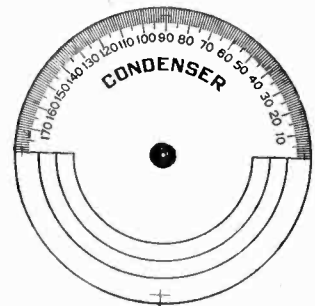
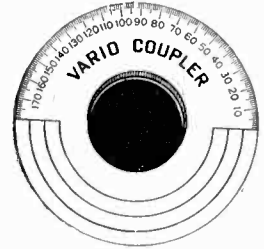
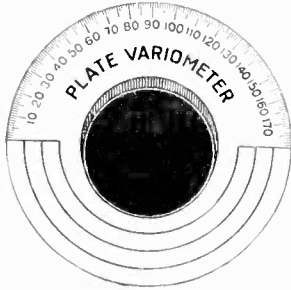

Variocoupler Dial	\$1.20
Grid Variometer Dial	\$1.40
Plate Variometer Dial	\$1.40
Condenser Dial	\$1.20
Condenser Dial, without knob	\$0.90

BAKELITE

Bakelite Dilecto Grade Panels cut and polished to your measurements, all sizes and weights \$2.25 lb. Cabinets, 6x6x12

\$2.50 and up

AETACO Inductance Coil Mounting

The AETACO 3 Coil Inductance Coil Mounting is manufactured from genuine Bakelite XXX Grade. Consists of three Bakelite standard plugs held in place by Bakelite frame. As the plugs are mounted on bearings, the coupler between the coils can be changed at will. All metal parts nickel plated. Connecting wire is soldered on rear of plugs to allow of easy connection. Not a molded affair. Shipping weight 1 lb.

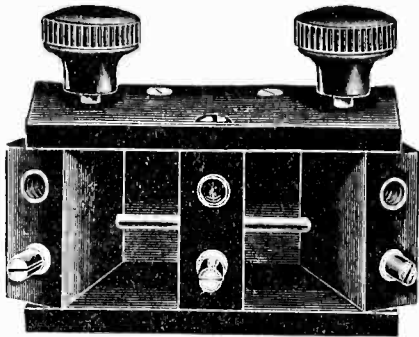

PRICE \$5.00

COMPLETE SETS FROM \$15.00 TO \$300.00

Free Bureau of Radio Information

This department is equipped to answer any and all questions on Radio Theory or Practice. Send in your questions today. And don't forget to visit this department when in New York.

Newest Model Crystal Detector

This new model AETACO Crystal Detector is mounted on Genuine Bakelite XXX Grade base — not molded. Has double rubber tip binding posts. Supplied with a super-sensitive, mounted galena crystal. Over-all dimensions of detector 2½ in. x 2 in. x 2 in. Net weight ¼ lb. Shipping weight ½ lb.

PRICE \$2.00

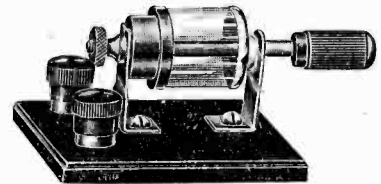

SEND 10c FOR OUR LARGE ILLUSTRATED CATALOG

American Electro Technical Appliance Co.

227-229-235 Fulton Street

New York City

PHONOTACH

Makes Your Phonograph a
Radio Loud Speaker

Adjust it in a minute

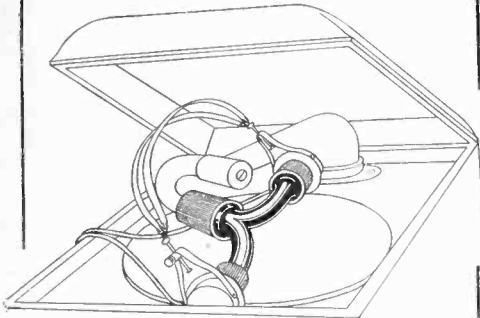

Patent applied for

**A NEW AND BETTER
LOUD SPEAKER**

AT A VERY LOW COST

Utilizes the Scientifically Designed Tone
Amplifier of the Talking Machine

**NO DISTORTION, FULL VOLUME
OF SOUND, CLEAR and MELLOW**

Send for One Today
PRICED ONLY \$3.00

W. A. MILLS

103 Park Avenue,
New York City

At your Dealer's or by Mail

Crystal Receiving Sets

\$17.50 with phones

Delivered to You. Range up to
50 miles. Immediate delivery.

We also specialize in a \$4.75
set (without phones). Dealers,
write for proposition.

GUTHRIE RADIO CO.

108 S. La Salle St., Chicago
PHONE DEARBORN 2680

PROTECTION AGAINST

Lightning
and Static

**JACOBUS
VACUUM**

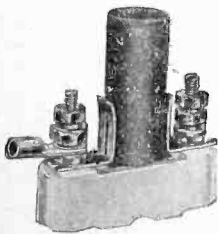

Aerial Protector
\$2.00, from your
dealer or sent
direct.

LISTED BY NATIONAL UNDER-
WRITERS

Eliminates Switches. Receiving stations
equipped with JACOBUS Protectors do
not require lightning or ground switches.
Protection every minute of the day
and night. No worry about throwing
switches.

Good for Innumerable Discharges. Dis-
charges of lightning or static on the
JACOBUS do not affect its life. After
conducting a discharge to the ground
the tube is ready for another operation.
Does not weaken or in any way affect
the efficiency of the set.

Apex Electrical Specialty Co.

INCORPORATED

83 Orange St., Newark, N. J.

**We can make
immediate delivery
of any Radio Supplies!**

WHATEVER you want, from parts
to complete installations, we are in a
position to give you delivery today.

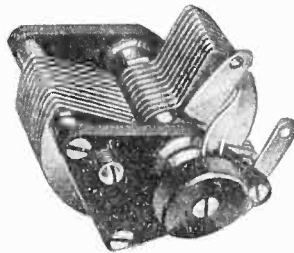

We carry a very large quantity
of all sizes new type of variable
condensers.

Immediate delivery
on all makes of
"B" Batteries

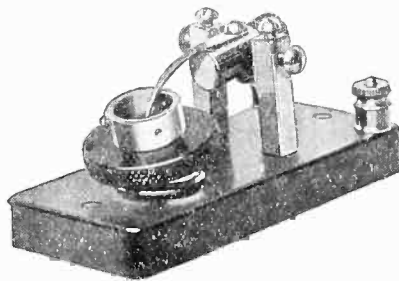
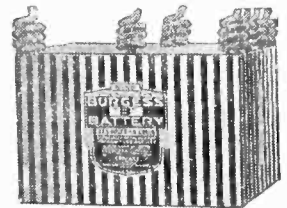

Crystal detectors, in-
ductances, vacuum tube
control panels, etc., right
in stock.

SELECT whatever apparatus or in-
struments you want from any stand-
ard catalog. Send us your order and
we'll fill it promptly.

Chicago fans—drop up and see us.
Mail in your order at once.

**PIONEER RADIO
ORGANIZATION**

ROOM 1626

FONE RAND. 4396

Masonic Temple Bldg.

Chicago, Ill.

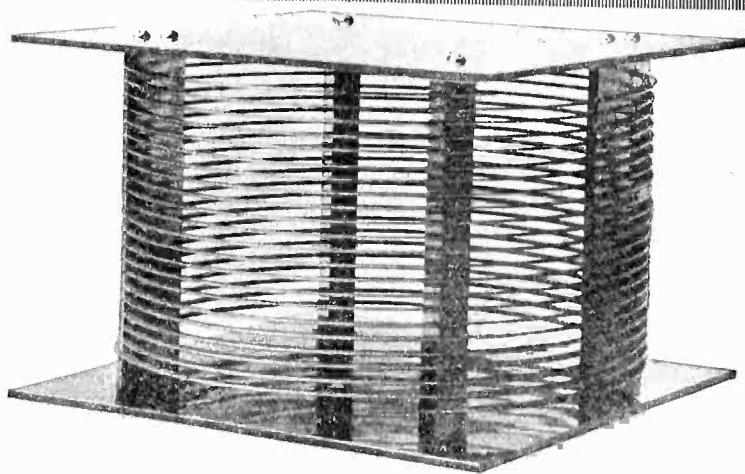

WIMCO CW 100 INDUCTANCE

WIMCO apparatus is very distinctive—it is very high grade and reasonably priced. For instance, the CW Inductance shown above—high conductivity, super insulation, low H.F. resistance, low distributed capacity—it is the ideal CW Inductance. We are specializing in CW apparatus. Send for catalog.

WIMCO products are sold in Chicago by

MANHATTAN ELECTRICAL SUPPLY CO.
8ZV—WIRELESS MFG. CO., CANTON, O.—8ZV

NEW EDITION OF RADIO QUIZ BOOK OUT!

"Quiz Book Preparing Applicants for U. S. Government New Rating of Radio Operators' License Examinations."

This new book contains 250 practical questions and answers on the New Rating for Radio Operators' License Exam. and includes the latest questions on Arc, Spark and Tube Transmitters along with Radio Compass and Radio Laws.

SENT TO YOU FOR ONE DOLLAR!

Publishers, Radio Topics
1112 North Blvd.
OAK PARK, ILL.

IT'S THE "BERRIES" SURE NUFF SAYS ONE OF THE LARGEST MAKERS OF AMPLIFIERS

A-A

3 to 1 ratio,
type R-2,
MOUNTED,
\$4.25.

SEMI-MOUNTED,
\$3.80.

UNMOUNTED,
\$3.35.

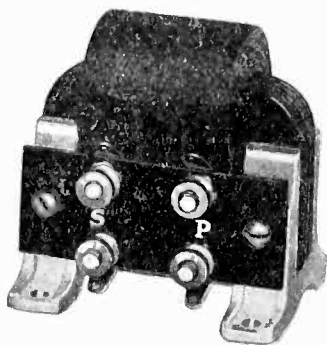

A-A

10 to 1 ratio,
type R-3,
MOUNTED,
\$4.50.

SEMI-MOUNTED,
\$4.00.

UNMOUNTED,
\$3.50.

Our new type R-3 amplifying transformer designed for the new U. V. 201 Radiotron and Cunningham tubes. Type R-2 is most efficient on the earlier tubes. Every transformer guaranteed. Type R-4 50 watt power tube sockets, \$3.00. For the U. V. 203 power tubes.

ALL-AMERICAN ELECTRICAL MFRS.
1516 NORTH LOREL AVE., CHICAGO, ILL.

ANOTHER RADIO GHOST

Benjamin Wolf of Falmouth, Ky., is haunted by numerous "ghosts" that disturb his slumbers. He hears voices, music, strange noises that come, apparently, from nowhere. But, being a modern, well-informed man, Mr. Wolf has accepted the theory of the radio experts, to whom he confided his troubles, that the manifestations are attributable to the fact that his bedsprings are in tune with many of the radiograms now so extensively broadcast. No doubt Mr. Wolf will insulate his bedsprings, or else tune them up so as to receive only what he wants to receive. Surely there are lullabies always float in the air when one wants to sleep. It is something to tune up the old bed and be sung to sleep by a world-famous prima donna!

Such experiences as Mr. Wolf's throw a light upon many of the "spirit manifestations" and "bewitchings" of old. Sound vibrations there have always been, and doubtless atmospheric conditions have often been such that by purely natural means these were transmitted vast distances. It is conceivable that Farmer Jones' wife, in Waycross, Ohio, might at daybreak say to Farmer Jones, "Get up and milk the cows!" and this message, striking a natural radio wave, might be borne to the ear of Farmer Doods, in Bushwhack, Australia, in the middle of the night, and would so impress Doods, as the voice of a spirit, that he would get up and milk his outraged cows at midnight, to the scandal of the neighborhood. There would be, of course, consequences.

But to get back to our bedsprings. If bedsprings are ready-made radio receivers, they should be studied and the secret of their power revealed. And, of course, the place to study bedsprings is in bed. If all radio fans will enthusiastically go to bed and stick to their beds, a great advance in the science may result. Here is a method of research that even Prof. Ding Whiddle, the inertist, might approve.

STATION WGY IS HEARD IN SAN FRANCISCO

The General Electric Station, WGY, at Schenectady, N. Y., recently succeeded in reaching San Francisco, Cal., a distance of about three thousand miles, a splendid feat for even so large a station, a description of which appear in this issue on page seven.

Department of Commerce Gets Out Book of Answers

Officials of the department of commerce have been so swamped with the work of answering questions sent them by radio enthusiasts that the government has just published a book which will answer most of the queries. It is called "The Principles Underlying Radio Communication," and was prepared by the United States bureau of standards of the department of commerce.

Elementary electricity, dynamo-electric machinery, radio circuits, electromagnetic waves, apparatus for transmission and receiving, electron tubes, are all discussed in the book, which contains 619 pages and which may be secured from the government printing office for \$1.



CHICAGO, MILWAUKEE & ST. PAUL RAILROAD INSTALLS RECEIVING SET ON THEIR TRAINS

Traveling for a number of hours on a railroad train provides little or no interest or excitement to the average passenger, so that the recent installation of a radio receiving set in the Club Car of the Pioneer Limited by the Chicago, Milwaukee & St. Paul Railroad has attracted much attention and has proven a novel pastime to those traveling on this road.

During the entire run of the Pioneer Limited it is within range of the Chicago broadcasting station, and the stock reports and baseball returns, which are sent out from this station regularly during the day, are of a special interest to the many business men riding over this road.

Some very comprehensive tests have been conducted on the Lackawanna Railway System, a complete report and photographs of which will appear in the next issue of this publication.



With the installation of a radio broadcasting station by The Detroit News of Detroit, Mich., literally the entire city and surrounding territory took up radio. The demands for apparatus were so great that The Detroit Electric Company opened the above shown store for radio exclusively. The general layout and arrangement of stock might well be taken as a model by other radio dealers.

CROSLEY HARKO SENIOR RADIO RECEIVER

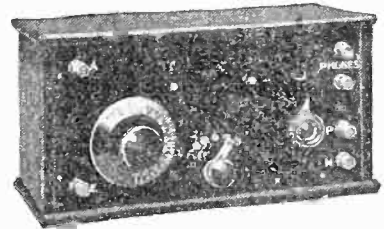

Complete tuner and audion detector assembled on a formica or other high grade dielectric panel, mounted complete in mahogany finish cabinet. Range, 150 to 600 meters, non-regenerative hook-up. Price without battery, tube or phones.....\$16.00

CROSLEY TWO-STEP AMPLIFIER

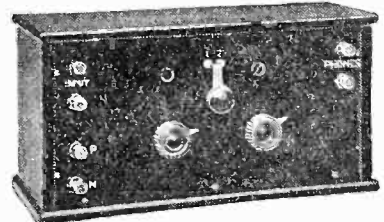

Complete with amplifying transformers, sockets, rheostats, switch, binding posts, etc., mounted on formica panel in mahogany finished cabinet. Price complete as shown in illustration\$25.00

We make a complete line of radio apparatus. It's "better—and costs less." Send for circulars.

Crosley Mfg. Co.

Radio Dept. T-5.

Cincinnati, O.

WIRELESS

Telephone and Musical

Concerts,

Also

Hawaiian and German Stations

Read With a Single Bulb

Are you satisfied with your receiving set? Would you like to build one that will receive over 6,000 miles on a single bulb and quit experimenting? One that will be the equal of any, regardless of claims or price? Using the instruments you now have, you will be able to duplicate the long distance records you read about every day.

Get our simple diagram of a complete short and long wave receiver, 175 to 20,000 meters, with which we read Honolulu, California, German, South American, French and English stations and practically all the high powered foreign and domestic stations, amateurs as far west as New Mexico and numerous telephone and musical concerts come in good.

Diagram and complete instructions, leaving nothing to guess about, will be promptly mailed for 50 cents in coin or stamps. Wire a set up and quit wasting good money.

VIRGINIA NOVELTY CO.

MARTINSBURG,

WEST VA.

WIRELESS DISTRIBUTORS

HANDLE
B. & P.
Insulators



No. 1



No. 2

Aerial
Neces-
sity
Insures
Safety
and
Perfect
Insula-
tion

**Immediate
Delivery**

Write for Exclusive Territory and
Quotation

Banister & Pollard Co.
206-208 Market Street
Newark, N. J.



RITZ-CARLTON HOTEL.

POWERFUL RADIO TELEPHONE STATION AT ATLANTIC CITY

The Ritz-Carlton Hotel at the world famous seashore resort has inaugurated a wireless telephone station for the reception of broadcasting concerts, news and other topics for the entertainment of its guests. The system is so arranged that guests in any part of this great new hostelry can "listen in" by calling the Radio Room

Complete Radio Set \$4.75 Postpaid

(Except Phones). Equal to any \$25 or \$30 set on the market; easily installed by anyone. Money Order or Check for \$4.75 brings this Sensational Radio outfit to your home. Satisfaction guaranteed or money back. **ORDER TODAY.** Demand enormous.
NATIONAL RADIO SALES CO.
14 W. Superior St., Chicago, Ill.
DEALERS WANTED.

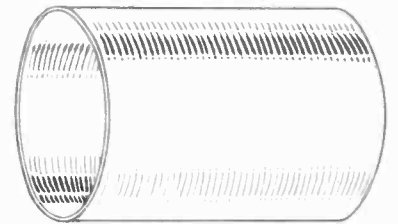

Specially Prepared Cores for Winding Inductance Coils, standard size, 3 ins. diameter, 4 1/2 ins. long. Other sizes furnished in quantity. Price 25 cents each. Send stamps or money order. Quantity prices furnished on application.

FIBRE CAN CORPORATION
4241 Ogden Ave., CHICAGO, ILL.

RADIO

We carry a full line of Radio Sets and Supplies of the best makes. Hear our sets before buying.

Chicago Electrical Supply Co.
360 W. Madison St. CHICAGO, ILL.

Do you want to earn some money in your spare time?

Soliciting subscriptions to **RADIO TOPICS** brings big money. Write for proposition.
RADIO TOPICS, OAK PARK, ILL.

Just What You Need for Assembling Radio Apparatus

THE FOUR-IN-ONE SCREW DRIVER
FOUR SCREW DRIVERS IN ONE

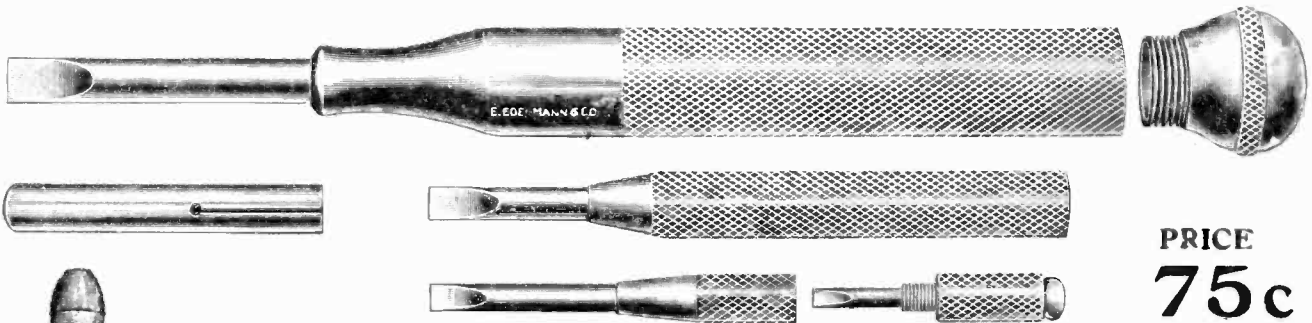

PRICE
75c

Actual size, length 6 inches. Weight, 3 ounces.

This clever Tool is just the right size to turn different Screws around your Radio Apparatus. Also handy around the house and machine shop. Blades are best grade steel carefully tempered. Beautifully Nickel Plated finish throughout.

Dealer's price, \$7.50 per unit of 15 Screw Drivers with Handsome Metal Display Case FREE. At every Wholesale Hardware House in the U. S. A., or send your orders direct to us. Single orders will be filled at 75c each by Prepaid Ins. Post. No extra charge for mailing.

"BREAK-NOT" BATTERY TESTER

It is absolutely necessary to test your RADIO STORAGE BATTERIES. Do this with a "BREAK-NOT" and get the most accurate reading.

Price, \$1.00, at all supply stores, or direct from us via Ins. Post. Write or wire today how many you want. Electrotypes furnished FREE to Jobbers and Dealers.

Note the patented construction which eliminates breakage.

Manufacturers of Automotive Accessories, Small Tools and Radio Parts.

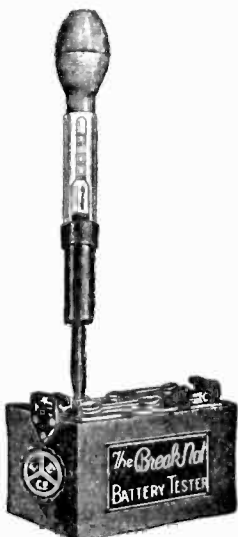

E. EDELMANN & COMPANY

We carry all items in stock in large quantities and ship the day we receive the order.
461-69 E. OHIO ST. CHICAGO, ILL.

The Radio Direction Finder and Its Application to Navigation

SHIP owners, radio operators, government departments and others are giving much attention to the importance of providing on shipboard radio direction-finding equipment by means of which the position of a ship can be quickly and accurately determined. This matter is receiving attention in various foreign countries as well as in the United States. The provision of radio direction-finding equipment on a ship may eliminate serious delays caused by a ship being unable to enter port during a fog because its position or the bearing of lighthouse is not known.

The radio direction finder is a device for determining in a simple manner the direction of a radio transmitting station with reference to the point at which the direction finder is located. The direction finder has a considerable number of very practical applications, of which one of the most important is its use as an aid to navigation.

Sound and visual signaling devices have been employed for many years as aids to navigation. Lighthouses and lightships, with their characteristic light flashes and sound signals, are established and maintained along the coasts and at harbor entrances in order that shipping may be carried on with maximum safety. During fog or thick weather, however, the sound and visual signaling devices often do not give reliable service.

The radio direction finder is not affected by fog and has the further advantage that it will operate over much greater distances than sound and visual signaling devices.

The Department of Commerce has developed a system of radio direction finding which has proved to be very simple, practical and dependable. This system has been developed by the Bureau of Standards in co-operation with the Bureau of Lighthouses. The first installations were made in the Third Lighthouse District, with headquarters at Tompkinsville, N. Y. A common type of direction finder which has been used for installation on shipboard consists of a coil of ten turns of insulated copper wire wound on a wooden frame four feet square, which is mounted so that it may be rotated about a vertical axis. Suitable radio receiving apparatus is used in connection with the coil, and in recent installations has consisted of a variable air condenser for tuning purposes, a balancing condenser for increasing the accuracy of observed bearings, a six-tube amplifier having three stages of radio-frequency amplification, a detector and two stages of audio-frequency amplification, batteries and suitable telephone receivers.

As the coil is revolved about its vertical axis, the intensity of the signal which is being received from the station whose location is to be determined diminishes until a minimum is reached, which occurs when the plane of the coil comes to a position at right angles to the line of direction to the radio transmitting station. At this point of minimum signal the radio bearing is read on a suitable scale, which may be either a fixed scale or the card of a magnetic compass.

RADIO PANELS
and other insulation for Wireless Work

BAKELITE-DILECTO

Grade XX Black was used by the Government during the war for this purpose. It is the

STANDARD OF THE WORLD

THE CONTINENTAL FIBRE COMPANY
NEWARK, DEL.

New York, 233 Broadway.
Pittsburgh, 301 Fifth Ave.
Los Angeles, 411 S. Main St.

Chicago, 332 S. Michigan Ave.
San Francisco, 75 Fremont St.
Toronto, Ont., Canada,
89 Wellington St., West.

Cardboard Tubing

Seamless—Grey
In Any Length Up to 28 Inches

	Per in. or Per Fraction	Foot
2½, 3 and 3½ in. dia.....	3½c	30c
4 and 4½ in. diameter.....	4c	35c
5 in. diameter.....	4½c	42c
5½ and 6 in. diameter.....	5c	50c

Postage extra; shipping weight 1 lb. per ft.
Binding Post, Switch Levers, Magnet Wire, Switch Points, Sliders and Slider Rods. Write for our prices
Dealers Write for Discounts

Michigan Radio Co.
2173 Hiliger Ave., Detroit, Mich.

RADIO CABINETS

We make to order radio wood cabinets and boxes, according to your specifications, in quantity lots, in our large cabinet factory.

We shall be pleased to receive your specifications or samples for quotations.

Jessen & Rosberg
656 N. Kedzie Ave., Chicago

WANTED

Subscription solicitors earning big money soliciting subscriptions for RADIO TOPICS Magazine. Everyone is interested in RADIO. Can use few more solicitors. Call or address G. B. Guthrie, 108 S. La Salle St., Suite 922. Phone Dearborn 2680.

The
June Issue
of
Radio Topics
will be the
Chicago Radio Show Number

Advertising Due in by MAY 20th



The HOME RADIO

HOW TO MAKE AND USE IT

By A. Hyatt Verrill

At last! A simple explanation of the making and use of a home radio outfit. Every step in construction is carefully directed and illustrated with numerous working diagrams. A cloth bound book. Postpaid for 75 cents.

"THE BROADCASTING GUIDE" 25c

Radio Educational Service

200(T) 5th Ave., R. 416,
NEW YORK CITY

Build Your Own

THERE is only one firm in this country devoted solely to instructing the amateur and novice how to build his own apparatus. Don't take a chance with diagrams you see published free. Nothing that is given away is ever good. Our BLUEPRINTS are 21x28 and are fool-proof, and behind them is our guarantee. In each drawing there is a bill of material of parts required, and you are enabled to ascertain in advance just what your new hook-up is going to cost. Write and ask for our free bulletin of twenty-two different designs. Radio enthusiasts may obtain this bulletin or the BLUEPRINTS from the distributor (if you live in the middle west and want to save time). All communications promptly answered. Ask for bulletin 4.

DISTRIBUTORS

Commonwealth Edison Co.

EDISON BUILDING, 72 WEST ADAMS ST.
CHICAGO, ILL.

OR

PRODUCERS OF BLUEPRINT DESIGNS

Experimenters' Information Service

45 PINEHURST AVE., NEW YORK CITY

CLASSIFIED ADVERTISING

Classified Advertising Rates ten cents a word for each insertion, cash to accompany order. Ads for June should be in before May 20. Minimum ten words, full count.

TELEGRAPHY

Telegraphy (Morse and Wireless) and Railway Accounting taught thoroughly. Big salaries. Great opportunities. Oldest, largest school. All expense low—can earn large part. Catalogue free. Dodge's Institute, Union St., Valparaiso, Indiana.

HELP WANTED

STOP DAILY GRIND. START SILVERING MIRRORS, auto headlights, tableware, etc. Plans free. Clarence Sprinkle, Dept. 40, Marion, Indiana.

FOR SALE

A-1 GALENA, perfect, tested and guaranteed, imbedded in special metal, price 35c; AA-1 GALENA (genuine), 50c postpaid. NATIONAL SPECIALTIES, 32-T Union sq., N. Y. C.

HALF K. W. DUBELIER CONDENSER, capacity .007, \$20.00; Acme Half K. W. Transformer, \$10.00; O. T. \$3.00; Dumore 7000 R.P.M. Motor, \$5.00; Magnetic Rectifier, \$10.00. James M. Hallowell, Jr., Chestnut Hill, Mass.

TWO COMPLETE W. E. Aeroplane Filtering outfits, 500 volt, brand-new, \$15.00 each. Address W-101, Radio Topics, Oak Park, Ill.

COMPLETE Radiophone Transmitting Station, consisting of generator, 200 watt, 750 volts; field rheostat, 6 five watt power tubes, three meters, filtering device, microphone and all necessary accessories, wired and mounted in a neat unit. Set has been heard consistently at five hundred miles. Will sell for five hundred dollars cash. Address W-102, Radio Topics, Oak Park, Ill.

In developing this system of direction finding, the Bureau of Standards has made a study of the distortion effects which may result from the presence of adjacent objects, such as the mass of a ship, and methods of eliminating errors which such distortion may cause in observed radio bearings. A particularly careful study has been made of distortion effects on shipboard and methods for correcting for these effects by calibration.

Practical methods have been developed for simplifying the operation of the direction finder. The direction finder is essentially a nautical instrument and should be installed on shipboard where it may be used directly by the navigator in taking bearings on radio signaling stations established on shore or on light vessels. This can be done with the simplified form. Bearings may thus be taken rapidly, at any time, and as often as desired.

This system developed by the Department of Commerce should be carefully distinguished from another system of determining positions by radio, which is now in use, in which the ship transmits signals to radio compass stations on shore, which report to the ship its position, by radio. This system avoids the delays and errors likely to occur in depending on radio compass stations on shore, since with the latter, even under the most favorable conditions, valuable time may be consumed in making a request for bearings, taking bearings, and getting the information back to the navigator on the ship.

The radio direction finder as used by the Department of Commerce involves a number of unique features. It is designed to be installed over the ship's binnacle carrying the magnetic compass card, so that the radio bearings are read directly on the magnetic compass card. An additional scale is attached to the top of the binnacle and marked with the corrections obtained by calibrating the radio direction finder. By these means the radio bearings are obtained in a simple and direct manner. The electrical features have been made such that the only operations necessary when taking a radio bearing are one adjustment in the radio receiving set, and the rotating of the direction finder coil.

A radio transmitting station intended primarily for direction finding work is often called a "radio beacon." Radio beacons may be installed at small expense on lighthouses and light vessels. The transmitting equipment may be designed to operate automatically by simply throwing a switch, so that no additional personnel is necessary. The radio transmitting equipment is set into operation by the lightkeeper, just as the other signaling devices at the light station. The expense of operation of the radio beacon is therefore small.

The Department of Commerce has established three radio beacons at the approaches to New York harbor, on Ambrose Light Vessel, Fire Island Light Vessel, and at Sea Girt Lighthouse, Sea Girt, N. J. These three beacons are now in regular commission and transmit waves of a frequency of 300 kilocycles per second (wave length= 1000 meters). A radio beacon is being installed on San Francisco Light Vessel No. 70. These beacons have automatic transmitting equipment, no operator being needed.

The Bureau of Standards has recently issued a publication describing this system of radio direction finding

MILWAUKEE, WIS., TO HOLD RADIO SHOW

A large radio and electric show will be held in the Civic Auditorium in Milwaukee June 21 to 25, inclusive, announces the Milwaukee Chamber of Commerce. The show will be under the direction of Spearman Lewis of Chicago.

CHICAGO STATION BROADCASTS BASEBALL REPORTS

Chicago Broadcasting Station, KYW, with the opening of the 1922 baseball season, has commenced the daily broadcasting of the detailed results of the National baseball games. The reports are sent from 3 to 6:30 p. m., and complete final reports are given at 7:30 p. m.

This novel service has added much to the interest in radio, and has caused a still greater demand for radio receiving instruments.

On Easter Sunday special church services were broadcasted from the Chicago Station as well as from many of the other stations throughout the country. The transmitting range of KYW will be greatly increased very shortly with the construction, which is now commenced, of one hundred and twenty-five-foot steel towers, replacing the present, which are only fifty feet high.

BELL SYSTEM CONSTRUCTING LARGE BROADCASTING STATION

The Bell Telephone System will inaugurate a radio toll broadcasting service in New York City within the next two weeks. The station is located at Walker and Lispenard streets, in a twenty-four-story building, three hundred and fifty feet high, upon which have been constructed antenna towers one hundred feet high. It is understood that it will be equipped with many new and modern features, including a new filtering device, whereby a number of wave lengths can be transmitted simultaneously, and a modulating system one hundred per cent perfect.

If certain experiments that are to be conducted with the toll system are successful, a nation-wide Bell Radiophone Service will result.

The broadcasting toll service will be available for all uses except advertising, this being restricted under the new regulations covering radiophone transmission. It is possible that political speeches will be accepted for transmission, and that any business concern may employ this utility for the entertainment of the public, being allowed a "by courtesy of" announcement.

RADIO CHECKS ELOPERS

An eloping young couple were halted in their flight when Mrs. Ethel Park of San Francisco flashed a radio message to the captain of a vessel bound for Portland, Ore., on which the elopers had taken refuge. Mrs. Park objected to the marriage of her 16-year-old daughter Bessie to Harry Helm. Another radio to the Portland police requested the arrest of Helm when the ship docked.

ANOTHER TELMACO

ACHIEVEMENT

THE TELMACOPHONE

Here is the height of Telmaco perfection. Equipped with Baldwin Type C Unit, Inverted horn, reflected tone. Equal to any other horn twice its length. Designed and perfected by expert acousticians. Complete in every detail.

Don't be misled into buying a loud speaker offered for less, and expect satisfaction, for a loud speaker of quality cannot be sold for less. Only after the most exhaustive tests and comparisons with the other loud speakers, and only after the most thorough research, laboratory tests, and field demonstrations has the Telmacophone been perfected, and offered now, for the first time, to the public.

No extras to buy. Nothing to get out of order.



TELMACO Amplifiers, Receivers, Detectors, Variometers and Variocouplers have earned a national reputation for quality, endurance and satisfaction not excelled by any other line. You can expect equal satisfaction from the Telmacophone.

PRICE COMPLETE \$20.00
Fully Guaranteed

Price without Baldwin Unit, but with cap attached **\$14.00**

We advise the purchase of the Telmacophone without unit for those who have Baldwin Unit of their own.

You can expect equal satisfaction from the Telmacophone.

RADIO DIVISION

TELEPHONE MAINTENANCE CO.

NOTE NEW ADDRESS

20 South Wells St., Dept C. Franklin 3986 Chicago, Ill.
5206 W. Madison St., Austin 7041 301 E. 58th St., Went. 858

The New Radio Broadcasting Station WGY of Schenectady, N. Y.

(Continued from page 7)

telephone attached keeps him constantly informed just how the program is going out and allows him to change position of the artists or microphone if such is necessary to improve the tone quality of the entertainment.

With the exception of the small pick-up devices or microphones and the switchboard, there is nothing in this room to indicate it as different from any musical studio.

In the apparatus room the sound waves are put through a number of steps of amplification by means of vacuum tubes, which increases their volume thousands of times. The amplified sounds are then put into a wire and sent to the broadcasting station, where they enter another bank of

vacuum tubes, known as modulators or molders of the electric waves.

Direct current at a high voltage is necessary for the operation of a transmitting station. To obtain this, a 220-volt alternating current line, which is but little higher than the voltage used for lighting purposes in the home, is boosted to 30,000 volts by means of a transformer. This voltage is then applied to a number of vacuum tubes, acting as rectifiers, which change the voltage to direct current. Placed between the rectifier and the modulator or molding tubes is a high power oscillator tube. The electric power entering this tube sets the ether into vibration and upon these vibrations the electric waves, molded into shape in the modulator tubes, are sent to the antenna to go out into space.

RADIO SERVICE AVAILABLE TO THE AMATEUR

(Continued from page 10)

to its higher efficiency, freedom from noise and its sharp wave, the continuous wave transmitter is gradually replacing the old spark type of transmitter.

Radiotelephone transmitting sets, as a rule, are much more expensive than radiotelegraph equipment covering the same range, and require for their proper adjustment and operation the supervision of an experienced operator.

RADIO RECEIVING EQUIPMENT

In order to receive radio telegraph and radiophone signals the following equipment is necessary:

Antenna (aerial).
Ground connection.
Antenna grounding switch.
Tuner.
Detector (with necessary batteries, etc.).

Regenerative circuits.
Head telephone receivers.
The following may be used in addition:

Amplifiers, with necessary accessories;

Loud speaking horn.

The cost of a complete radio receiving outfit ranges from about \$35 for a simple set with mineral detector to \$200 or more for a highly sensitive installation of the best grade. For \$125 or less a very satisfactory complete set may be installed, containing an electron tube detector; additional equipment may then be added at any time to reach the highest sensitivity.

Antenna

Many types of antenna are in general use. The particular type of antenna used, and its exact location, will in general be determined by the local conditions, such as dimensions of the property, location of convenient high supports, avoidance of interfering trees, etc. Where an equal choice between several antenna locations exist, and it is desired to make use of the slight directional characteristics of the average inverted "L" type of antenna, the free end of the antenna should point away from the station which is to be received most efficiently.

A good form of receiving antenna for general radiophone reception consists of a single wire, 100 to 250 feet long, and 30 feet or more above the ground. The antenna should be as far as possible from all surrounding objects, and not run parallel to nearby electric wires. In general, the more free the antenna is, i. e., the higher it is above surrounding objects, the better it will receive. Great height, however, is not essential, and satisfactory reception has been accomplished even on wires strung inside the attic of small dwellings. Where it is preferred to make the antenna less than 100 feet in length it should consist of two or more parallel wires, held apart by a wooden spreader at each end. The usual conductor for an antenna consists of 7 strand No. 22 hard drawn copper wire, or of No. 14 bare hard drawn copper. Where a great safety factor of strength is desirable, as in commercial installations, or where a long span is used, or the an-

—you Can't buy a better receiving set anywhere at any price

\$40⁰⁰

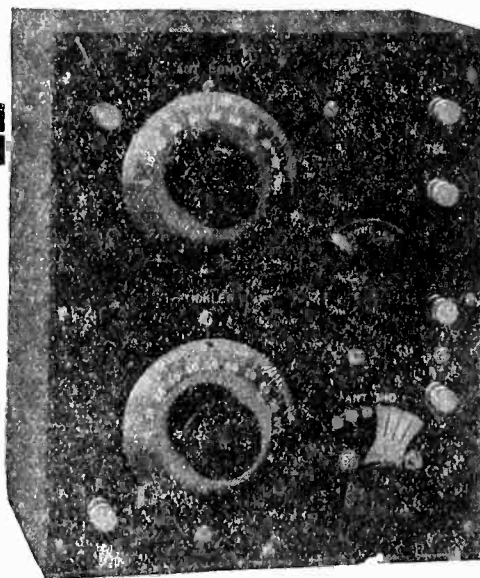

Licensed under Armstrong U. S. Patent No. 1,113,149

SPECIFICATIONS

Clapp-Eastham Type H. R.

Regenerative Receiver

Panel—Condensite handsomely finished.
Cabinet—Solid Mahogany.
Condenser—Balanced type, 2 Rotary, 3 Stationary Plates. Built as a Vernier.
Dials—Indestructible metal. White figures on black ground.
Antenna Inductance—Wound on Formica Tube.
Plate Inductance—Wound on molded ball.
Rinding Posts—Black Rubber Covered.
Switch—Fan Blade.
Rheostat—C. E. Type H 400.
Circuit—Single circuit regenerative. Licensed under Armstrong U. S. Patent No. 1,113,149.
"B" Battery—Contained in compartment inside cabinet or external as desired.

QUALITY—and at a reasonable price—is the appeal that the Clapp-Eastham Type H. R. Regenerative Receiver makes to men who know wireless less equipment. The specifications and the Clapp-Eastham reputation tell them the story. To the novice, the appearance of the set, the clear, sharp tones, its wide range, and the perfect regeneration on all wave-lengths between 180 and 825 meters, is convincing evidence. The quality in the solid mahogany Cabinet is reflected all throughout the set. Ask your dealer to show it to you. If he's temporarily out—and he may be, because the demand has been phenomenal—write us. Send 6c in stamps for the C-E Radio Catalog. If you're at all interested in wireless you ought to have it.

Clapp-Eastham Company

Radio Engineers and Manufacturers

118 Main Street

Cambridge, Mass

tenna crosses power lines, it is better to employ 7 strand No. 22 or No. 18 Phosphor Bronze or Silicon Bronze wire.

Each end of the antenna should be insulated from its support by means of an insulator of electrose, porcelain, glass or other material. Small insulators, having a creepage path of several inches, will suffice for receiving purposes. The insulator is preferably attached to its support by means of a few feet of rope or sash cord; if a wire is used, a second small insulator is best inserted near the other end of this wire, so as to separate effectively the antenna from the grounded portion of the wire. A pulley at one or both ends of the antenna will be found convenient for raising or lowering it when desired.

In the case of the single-wire antenna, one end of the antenna is usually continued straight down, from the insulator, to form the "Lead-in," which connects the antenna with the instruments. Where a multiple-wire antenna is employed, a separate lead-in wire should be attached at, or near, the end of each antenna wire. These lead-in wires may be bunched together a short way down from the antenna, or may all remain separate to the point where they enter the building. All electrical connections in the antenna, as well as in the ground system, should be soldered, to avoid poor contacts due to corrosion.

The lead-in is led into the building through a lead-in bushing or insulator. This may consist of a special electrose insulator, or of an ordinary porcelain

tube, as used in house wiring. Inside the house, the wiring should be as short and direct as possible, and not near other wires, piping, girders, etc. To avoid electrical losses, it is best to locate the apparatus within a few feet of where the lead-in enters the house.

Where conditions prevent the erection of an outdoor type antenna, good results are often achieved with antenna wires strung inside the building, preferably in the attic. Where a long span is not available, an increased number of wires should be used (six, eight or more). These wires should be kept away from and not run parallel to nearby electric light wiring, piping, or other grounded metallic objects. In the case of indoor antennae, dry wood will generally give sufficient insulation.

In some cases, where the installation is of a temporary nature, it is even found possible to use the eaves-trough or gutter-pipe for the reception of signals.

Indoor coils or loop-antennae are generally not found practicable, unless used with many stages of amplification.

Ground Connection

A sufficient ground connection is generally afforded by the water supply system. Where a steam or hot water pipe is more convenient it may be found to give satisfactory results. Sometimes increased strength of signal results from the use of several different ground connections together. A rod driven into the ground, such as a telephone ground, is generally not satisfactory. A lightning rod ground will often give good results.

The wiring from the tuner to the ground connection should be no longer than necessary. For short leads the wire should not be smaller than No. 18; a larger size wire is preferable, especially for connections exceeding a few yards in length.

To insure good electrical contact with the ground system, both the pipe and the wire connecting to it should be well scraped and the connection preferably soldered.

(To be continued)

THE RADIO LIMITED

(Continued from page 17)

period were as sensational as those obtained on April 5, nor as convincing of practical application.

Mr. L. B. Foley, superintendent of electrical communication of the Lackawanna, has led the way of such communication from the early days of Morse. He brushed aside opposition and ridicule when the telephone was a novelty, and his experiments with wireless in 1913, although even discouraged by the Marconi organization, did more to attract universal attention to this new art than anything that had occurred in connection with it, with the possible exception of the Titanic disaster.

Mr. Foley is convinced that Wednesday's experiment proves con-

Get Loud, Clear Signals

Full 4 to 1 Amplification Without Howling!



ORDER BY MAIL



Signals 2 to 10 Times Louder and Clearer

A properly designed variometer brings in signals 2 to 10 times louder than the various other types of inductances on the market. With this fact in mind we have designed what we believe to be the "last word" in variometers—the "Benwood" variometer shown above. Inductances are wound with double cotton covered wire and no shellac, paint or varnish is allowed to cover the wire and diminish the effectiveness of operation.

The "Benwood" features are—Minimum distributed capacity, minimum distance between stator and rotor, large size wire on both coils, positive contact bearings and proper design (mechanical as well as electrical). This variometer will give splendid results on wave lengths from 150 to 650 meters when used with the average variocoupler. Price, each (add postage) **\$5.00**

CATALOG

Send 10c in stamps for the Benwood catalog, which includes complete price list on all Benwood apparatus and also complete catalog and price list of the DeForest Radio Equipment, for which we have the exclusive territory west of the Mississippi.



An Improvement on Any Set

Every amateur takes pride in the appearance of his set, and in fact a great deal depends upon the neat, efficient construction for best results. This high-grade indicating dial is beautifully nickel plated, 3 5-16 inches in diameter, and has extra heavy 1 5/8 inch knurled edge Bakelite knob. It is drilled for 1/4 inch rod, and has setscrew to make positive grip. 180° graduations permit closer adjustments, and metal disc acts as an efficient shield for the operator. It will fit perfectly flat on your panel and add greatly to its appearance. The "Benwood" Superior Dial, a big value at (add postage) **\$1.50**

Dealers: Write for Our Proposition

THE BENWOOD CO. Inc.

1115 OLIVE ST., ST. LOUIS, MO.
"WORLD WIDE MAIL ORDER SERVICE."

clusively that installations can be immediately effected which will permit the passenger on a railroad train to communicate at any time with his home or office or vice versa, using the ordinary telephone at the home and

relaying to radio at a wireless station, conveniently located geographically. There is also no doubt that such communication will tend to materially increase the safety factor of railroad operation.



Make Your Own Radio Receiving Sets

ENJOY the concerts, market reports, latest news, etc., as sent out by large broadcasting stations. This NEW copyright book "EFFICIENT RADIO SETS" shows how to make INEXPENSIVE set for receiving wireless broadcastings. Sent postpaid for 25c. Address J. C. Dorn, Pub., 725 S. Dearborn St., Dept. 107, Chicago.

RADIO TELEPHONE BROADCASTING STATION FOR SALE

Complete transmitter, consisting of a 2,000 volt, 600 watt motor generator unit and a 4-50 watt tube set in one unit. Will sell for \$800 cash. Address W 103, Radio Topics, Oak Park, Ill.

Crowds Come to Our Radio Concerts Every Day!

—you also are cordially invited to attend these daily interesting demonstrations

Every member of the family will find delight in hearing the Radio Telephone concerts that are given in our spacious showrooms every day. Especially to those that have never had the pleasure of hearing a concert by radio, it will prove a novel experience, and if you are interested in the purchase of equipment for the purpose of receiving the concerts in your own home you are here given an opportunity to hear these sets in operation, to learn of their simple operation and to get any information about radio that you might desire.

We carry a complete line of Westinghouse apparatus together with all of the necessary radio accessories.

The radio amateurs in this vicinity are also requested to drop in at our showrooms, which are located above the Tri-State Garage, Mamaroneck Avenue, White Plains, N. Y.

You are under no obligations to make purchases when attending our concerts. If you desire information or are interested in the purchase of material you can be assured of prompt and courteous service.

20th Century Wireless Telephone Corp.

J. F. DOWD, Mgr.

2-4 Mamaroneck Ave.

White Plains,

N. Y.

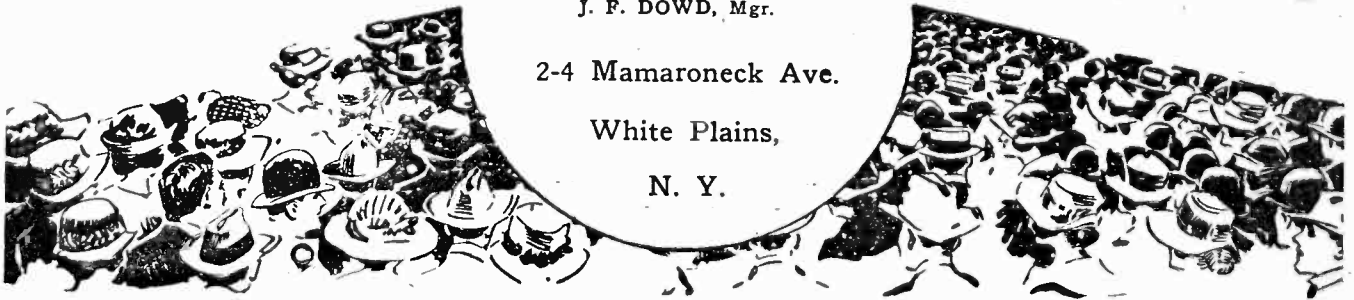

Do You Buy Your Copies of

RADIO TOPICS

The National

Radio Monthly

from the News Stands?

—If so, you may be disappointed, for the dealers seldom have a supply more than two days.

Every issue is bigger and better, and if you would get every issue, sign up for a year, today—

RADIO TOPICS,
OAK PARK, ILL.

Gentlemen: I am inclosing herewith two dollars (\$2.00) for a one-year subscription.

NAME

STREET

CITY AND STATE.....

If Figures Interest You—

The circulation of RADIO TOPICS

for March was..... 7,200
for April was.....47,500
for May was.....77,300

—and next month it will likely be double this.

Consider the influence of RADIO TOPICS from an advertising standpoint. The results are tremendous. For you to circularize our readers it would cost you:

for postage.....\$1,600.00
for circulars..... 1,000.00
for envelopes..... 250.00
for addressing..... 300.00

\$3,150.00

But you can effectively reach every reader with a full page advertisement for less than \$300.00.

If advertising did not pay we wouldn't use this valuable space, nor would the 34 others who are advertising in RADIO TOPICS.

YOU will eventually, so why not start in the June issue?

SIGN THIS TODAY AND MAIL IT IN

Immediate Delivery of Radio Sets

Harko Senior V. T. Radio Receivers. Good for receiving broadcast news, concerts, etc., at a distance of from 300 to 500 miles. The best set on the market for anywhere near the price. Price, without tubes, phones or batteries **\$20.00**
 Price, with tubes, phones, but without batteries..... **\$35.00**
 Harko two-step amplifier. This amplifier hooked up to the Harko Senior V. T. Radio Receiver will give you a range of 1,200 miles. Price, without tubes **\$25.00**
 Harko Junior Crystal Detector Receiving set has a range of 20 to 40 miles, complete without headphones **\$9.00**

We Can Make 24-Hour Delivery from Stock on Any of These Outfits

DEALERS: We will give you Liberal Discounts, and can make immediate delivery on any quantity. Write or wire your needs.

The United Radio Manufacturing Co.

JOBBERS AND MANUFACTURERS

700 First National Bank — Soo Line Building

MINNEAPOLIS, MINN.

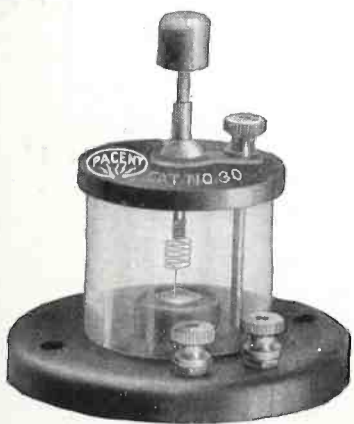

**PACENT
CRYSTAL DETECTOR**

The Pacent Crystal Detector is perfect in construction and reasonable in price. It is dust-proof, rust-proof and fool-proof. Has molded top and base with glass cover. Crystal instantly accessible. All parts heavily nicked and highly polished. A truly beautiful instrument, incorporating every feature a good detector should have. Pacent made and Pacent stamped.

Catalog No. 30A
 Pacent Crystal Detector
 Price without crystal. **\$1.50**

Catalog No. 30
 Pacent Crystal Detector
 Price with crystal. **\$1.75**

Three More Pacent Radio Essentials



DUBILIER TYPE 600 CONDENSER

This condenser, manufactured by the Dubilier Condenser Company by the superior Dubilier process, can be secured for your receiving equipment. The Dubilier Type 600 Condenser has accommodations for a grid leak, yet the condenser costs less than a grid leak condenser purchased separately and is provided with Fahnestock connectors. Use Dubilier Condensers.

Capacities up to 0.005 mfd. **\$.75**
 Capacities over 0.005 to .01 mfd. **1.00**

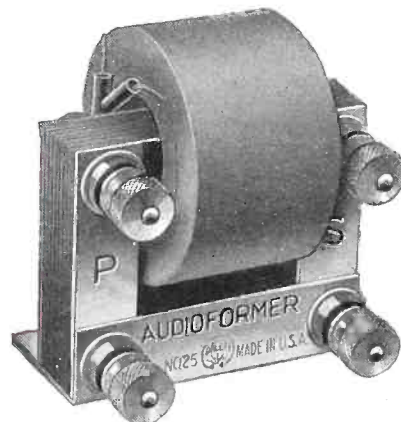

PACENT AUDIOFORMER

Here is the smallest and most efficient audio-frequency transformer on the market today. It is being manufactured especially for the reception of radio telephone music and speech and is so designed as to give maximum efficiency at all audio-frequencies. Pacent made, the Audioformer will make music worth listening to.

Catalog No. 25
 Pacent Audioformer..... **\$6.00**

Pacents Electric Company, Inc.

LOUIS GERARD PACENT, President

Member of Radio Section, Associated Manufacturers of Electrical Supplies

150 NASSAU ST.

NEW YORK CITY

RADIO FANS

Here is something you really need—

A Cabinet to properly house and protect your receiving outfit

WITH great broad-casting stations bringing hourly to your home either the world's best music, speeches by noted men, bed-time stories, important news events, daily weather and market reports, your receiving set is the most attractive article you possess. Radio concerts are nightly given in thousands of homes, and friends and neighbors come to hear them. Usually they find the receiving set—with its mysterious, magical power—on a table, chair, or sometimes the floor itself

Why not protect its wonderful mechanism—costly to replace—in a cabinet designed especially for the purpose?

Why not give your receiving set, around which all gather with absorbing interest, a proper setting?

The cost is trifling when its value and service are considered, and the cabinet of superior finish and beautiful period design at once becomes the most attractive piece of furniture in your home.

WIDDICOMB Cabinets are built by The Widdicomb Furniture Company, for 56 years recognized leaders as fashioners of beautiful furniture. Their exclusive creations in period design set the standard for fine cabinet work. Built in the most popular period designs: Chippendale, Sheraton, Adam, Queen Anne and Early American art. Widdicomb cabinets are produced in a great variety of styles, in genuine Mahogany, Walnut or Oak, to suit any decorative plan and to blend harmoniously with the furnishings of the most tastefully appointed room.

These cabinets will hold any of the standard receiving outfits, including battery, tone-arm and Widdicomb special Amplifying Chamber.

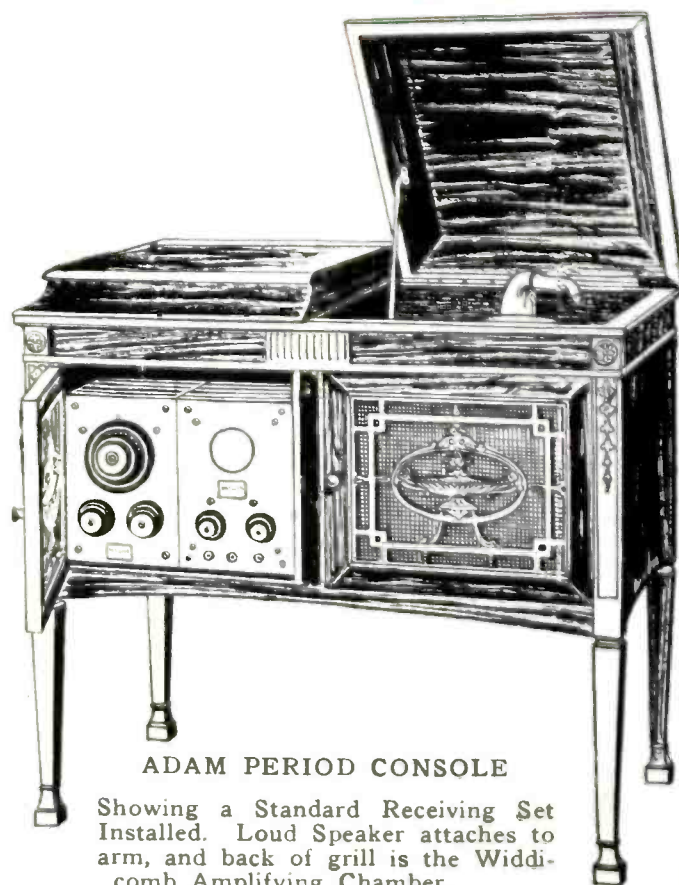

ADAM PERIOD CONSOLE

Showing a Standard Receiving Set Installed. Loud Speaker attaches to arm, and back of grill is the Widdicomb Amplifying Chamber.

Cabinets can be furnished with or without the famous Widdicomb phonograph equipment as desired. Prices the lowest on the market, quality considered.

Write or call for handsomely illustrated catalog giving description and special prices. It is free

The Widdicomb Sales Co.

327 S. LA SALLE STREET

CHICAGO, ILLINOIS